



SIPMA S.A.
ul. Budowlana 26
20-469 Lublin, Polska
tel. (+48) 81 44 14 400
www.sipma.pl

*Rozsiewacze nawozów
SIPMA RN 610 ANTEK*



TABELE WYSIEWU

Wydanie I - 2019

Sposób posługiwania się tabelą wysiewu

W tabelach podane są ustawienia łopatek na skali tarczy w następujący sposób:

Np.

ŁD I-2,3

ŁK I-1,4

Oznacza to:

- Łopátka Długa I ustawiona na skali tarczy pionową powierzchnią łopátki na wartość 2,3 (dwie duże działki i trzy małe)
- Łopátka Krótka I ustawiona na skali tarczy pionową powierzchnią łopátki na wartość 1,4 (jedna duża działka i cztery małe)

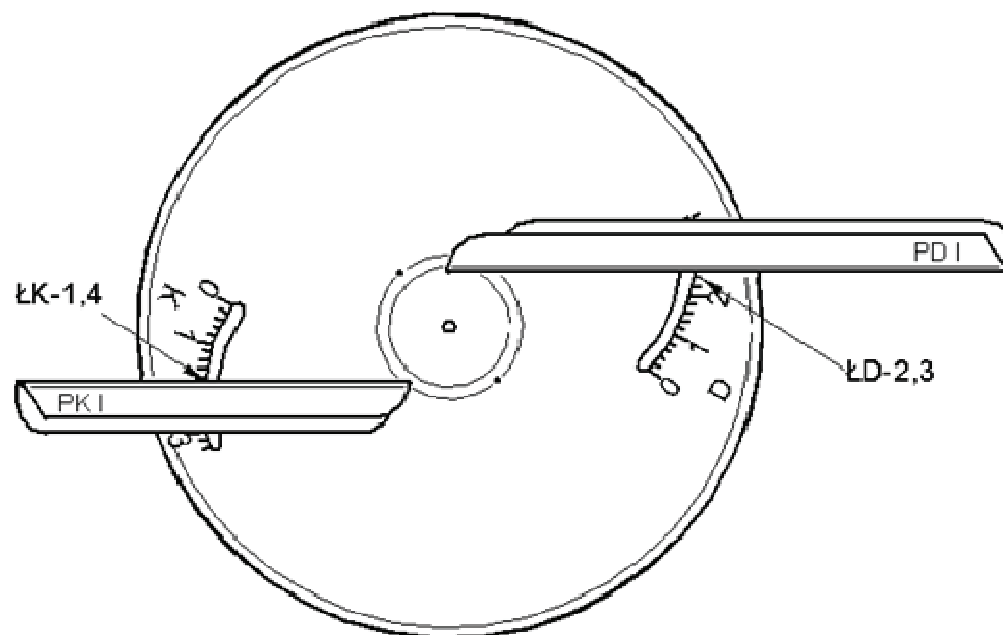

Rys..1. Tarcza z przykładowo ustawionymi łopatkami.

Sposób posługiwania się tabelą wysiewu

Dawka nawozu wysiewanego na jednostkę powierzchni zależy od:

- wielkości szczeliny, przez którą nawóz wydostaje się ze zbiornika na tarcze rozsiewające,
- prędkości roboczej agregatu,
- szerokości pasa rozsiewu,

Zwracamy również uwagę, że indywidualne właściwości rozsiewanego nawozu, takie jak odchylenia właściwości fizycznych (ciężar właściwy, granulacja, zdolność do poślizgu itd.) oraz różne zachowania nawozu w wyniku wpływów pogodowych i/lub warunków składowania, mają ogromny wpływ na jego równomierny rozkład poprzeczny oraz dawkę rozsiewu.

Dlatego nie możemy zagwarantować, że Państwa nawóz, o tej samej nazwie i od tego samego producenta posiada takie same właściwości, jak podany nawóz w tabeli rozsiewu. Podane zalecenia dotyczące ustawień dla równomiernego rozkładu poprzecznego dotyczą wyłącznie dawki a nie rozkładu składników odżywczych (dotyczy to w szczególności nawozów mieszanych). Wyklucza się w tym przypadku odpowiedzialność producenta za szkody powstałe w wyniku nawożenia.

W przypadku rozsiewania nawozu innego niż wymieniane w tabelach, należy przyjąć wartości przybliżone wg tabel dla nawozu o podobnych do stosowanego właściwościach fizycznych, lub zgłosić telefonicznie do Serwisu SIPMA SA, który poda zalecenia ustawienia.

Przed uruchomieniem maszyny przeczytać instrukcję obsługi i przestrzegać zawartych w niej wskazówek dotyczących bezpieczeństwa!

Oznaczenie nawozów w sterowniku

Lp.	Pełna nazwa nawozu w tabeli wysiewu	Nazwa nawozu w sterowniku w wersji polskiej	Nazwa nawozu w sterowniku w wersji obcej
1	N 32 Zaksan	1. Zaksan	1. N 32
2	N 27,5 Salmag	2. Salmag	2. N 27,5
3	N 27,5 Salmag z siarką	3. Salmag + S	3. N 27,5 + S
4	NPK 4-16-18 Amofoska	4. Amof. 4-16-18	4. NPK 4-16-18
5	NPK 4-10-22 Amofoska CORN	5. Amof. 4-10-22	5. NPK 4-10-22
6	NPK 5-10-25 Amofoska	6. Amof. 5-10-25	6. NPK 5-10-25
7	NPK 4-12-12 Amofoska	7. Amof. 4-12-12	7. NPK 4-12-12
8	NPK 4-12-20 Amofoska	8. Amof. 4-12-20	8. NPK 4-12-20
9	Super Fos Dar 40	9. SuperFosDar40	9. SuperFosDar40
10	NPK 4-12-32 Polifoska 4	10. Polifoska 4	10. NPK 4-12-32
11	NPK 6-20-30 Polifoska 6	11. Polifoska 6	11. NPK 6-20-30
12	NPK 8-24-24 Polifoska 8	12. Polifoska 8	12. NPK 8-24-24
13	NP 18-46 POLIDAP	13. Polidap	13. NP 18-46
14	N 46 Urea Mocznik.pl	14. Mocznik.pl	14. N 46 Mocznik
15	N 27 CAN Saletrzak 27 standard	15. Saletrzak 27	15. N 27 CAN
16	NS 26-13 Saletrosan 26	16. Saletro. 26	16. NS 26-13
17	NS 21-24 Siarczan Amonu AS21 macro	17. Siar. AS21 m	17. NS 21-24 m
18	NS 21-24 Siarczan Amonu AS21 select	18. Siar. AS21 s	18. NS 21-24 s
19	N 34 Saletra Amonowa PULAN	19. Sal. Pulan	19. N 34
20	N 46 Mocznik PULGRAN	20. Pulgran	20. N 46 Pulgran
21	N 46 Mocznik PULREA	21. Pulrea	21. N 46 Pulrea

Spis tabel

Nawozy

1.	N 32 Zaksan	8
2.	N 27,5 Salmag	11
3.	N 27,5 Salmag z siarką.....	14
4.	NPK 4-16-18 Amofoska	17
5.	NPK 4-10-22 Amofoska CORN	20
6.	NPK 5-10-25 Amofoska	23
7.	NPK 4-12-12 Amofoska	26
8.	NPK 4-12-20 Amofoska	29
9.	Super Fos Dar 40.....	32
10.	NPK 4-12-32 Polifoska 4	35
11.	NPK 6-20-30 Polifoska 6	38
12.	NPK 8-24-24 Polifoska 8	41
13.	NP 18-46 POLIDAP.....	44
14.	N 46 Urea Mocznik.pl.....	47
15.	N27 CAN Saletrzak 27 standard	49
16.	NS 26-13 Saletrosan 26.....	53
17.	NS 21-24 Siarczan Amonu AS21 macro	56
18.	NS 21-24 Siarczan Amonu AS21 select	59
19.	N 34 Saletra Amonowa PULAN.....	62
20.	N 46 Mocznik PULGRAN.....	65
21.	N 46 Mocznik PULREA	68



Tabela wysiewu

SIPMA RN 610 ANTEK

Tarcza: 430

Lopatkki 0



N 32 Zaksan

Grupa Azoty Zakłady Azotowe Kędzierzyn S.A.

Formuła nawozu: N 32
Klasa ziarnowa: granule 2-5 mm, nie mniej niż 95%
Gęstość nasypowa: 0,98-1,0 kg/dm³

Szerokość robocza	10 m						12 m						15 m						16 m						18 m					
Typ i ustawienie łopatek	LD 0 - 2,5						LD 0 - 2,5						LD 0 - 3,2						LD 0 - 3,4						LD 0 - 3,4					
	LK 0 - 2						LK 0 - 2,2						LK 0 - 2,2						LK 0 - 2,2						LK 0 - 2,4					
Obroty	540 obr/min						540 obr/min						540 obr/min						540 obr/min						540 obr/min					
Dawka wysiewu	kg/ha																													
Nastawa	Prędk. robocza [km/h]						Prędk. robocza [km/h]						Prędk. robocza [km/h]						Prędk. robocza [km/h]						Prędk. robocza [km/h]					
	6	8	10	12	14	16	6	8	10	12	14	16	6	8	10	12	14	16	6	8	10	12	14	16	6	8	10	12	14	16
4	73	55	44	37	31	27	61	46	37	31	26	23	49	37	29	24	21	18	46	34	27	23	20	17	41	31	24	20	17	15
4,5	92	69	55	46	39	35	77	58	46	38	33	29	61	46	37	31	26	23	58	43	35	29	25	22	51	38	31	26	22	19
5	111	83	67	55	48	42	92	69	55	46	40	35	74	55	44	37	32	28	69	52	42	35	30	26	62	46	37	31	26	23
5,5	136	102	82	68	58	51	113	85	68	57	49	43	91	68	54	45	39	34	85	64	51	43	36	32	76	57	45	38	32	28
6	165	124	99	82	71	62	137	103	82	69	59	51	110	82	66	55	47	41	103	77	62	51	44	39	92	69	55	46	39	34
6,5	193	145	116	97	83	72	161	121	97	81	69	60	129	97	77	64	55	48	121	91	72	60	52	45	107	81	64	54	46	40
7	238	178	143	119	102	89	198	149	119	99	85	74	159	119	95	79	68	59	149	111	89	74	64	56	132	99	79	66	57	50
7,5	281	211	169	141	121	105	234	176	141	117	100	88	187	141	112	94	80	70	176	132	105	88	75	66	156	117	94	78	67	59
8	320	240	192	160	137	120	267	200	160	133	114	100	214	160	128	107	92	80	200	150	120	100	86	75	178	133	107	89	76	67
8,5	369	276	221	184	158	138	307	230	184	154	132	115	246	184	147	123	105	92	230	173	138	115	99	86	205	154	123	102	88	77
9	423	317	254	211	181	158	352	264	211	176	151	132	282	211	169	141	121	106	264	198	158	132	113	99	235	176	141	117	101	88
9,5	485	364	291	243	208	182	404	303	243	202	173	152	323	243	194	162	139	121	303	227	182	152	130	114	269	202	162	135	115	101
10	547	411	328	274	235	205	456	342	274	228	195	171	365	274	219	182	156	137	342	257	205	171	147	128	304	228	182	152	130	114
10,5	630	472	378	315	270	236	525	394	315	262	225	197	420	315	252	210	180	157	394	295	236	197	169	148	350	262	210	175	150	131
11	697	523	418	348	299	261	581	436	348	290	249	218	465	348	279	232	199	174	436	327	261	218	187	163	387	290	232	194	166	145
11,5	778	584	467	389	333	292	648	486	389	324	278	243	519	389	311	259	222	195	486	365	292	243	208	182	432	324	259	216	185	162
12	876	657	526	438	376	329	730	548	438	365	313	274	584	438	351	292	250	219	548	411	329	274	235	205	487	365	292	243	209	183
12,5	966	724	580	483	414	362	805	604	483	402	345	302	644	483	386	322	276	241	604	453	362	302	259	226	537	402	322	268	230	201
13	1074	806	644	537	460	403	895	671	537	448	384	336	716	537	430	358	307	269	671	503	403	336	288	252	597	448	358	298	256	224
13,5	1181	886	709	591	506	443	985	738	591	492	422	369	788	591	473	394	338	295	738	554	443	369	316	277	656	492	394	328	281	246
14	1310	982	786	655	561	491	1091	819	655	546	468	409	873	655	524	437	374	327	819	614	491	409	351	307	728	546	437	364	312	273
14,5	1415	1061	849	707	606	531	1179	884	707	590	505	442	943	707	566	472	404	354	884	663	531	442	379	332	786	590	472	393	337	295
15	1564	1173	939	782	670	587	1304	978	782	652	559	489	1043	782	626	521	447	391	978	733	587	489	419	367	869	652	521	435	372	326
15,5	1673	1254	1004	836	717	627	1394	1045	836	697	597	523	1115	836	669	558	478	418	1045	784	627	523	448	392	929	697	558	465	398	348
16	1872	1404	1123	936	802	702	1560	1170	936	780	669	585	1248	936	749	624	535	468	1170	878	702	585	502	439	1040	780	624	520	446	390
16,5	1992	1494	1195	996	854	747	1660	1245	996	830	712	623	1328	996	797	664	569	498	1245	934	747	623	534	467	1107	830	664	553	474	415
17	2204	1653	1322	1102	944	826	1836	1377	1102	918	787	689	1469	1102	881	735	630	551	1377	1033	826	689	590	516	1224	918	735	612	525	459
17,5	2272	1704	1363	1136	974	852	1893	1420	1136	947	811	710	1515	1136	909	757	649	568	1420	1065	852	710	609	533	1262	947	757	631	541	473
18	2434	1825	1460	1217	1043	913	2028	1521	1217	1014	869	761	1623	1217	974	811	695	608	1521	1141	913	761	652	570	1352	1014	811	676	579	507
18,5	2462	1846	1477	1231	1055	923	2051	1539	1231	1026	879	769	1641	1231	985	821	703	615	1539	1154	923	769	659	577	1368	1026	821	684	586	513

LD I - Łopatkka I długa
LD II - Łopatkka II długa
LK I - Łopatkka I krótka
LK II - Łopatkka II krótka



Tabela wysiewu

SIPMA RN 610 ANTEK

Tarcza: 430

Lopatki I

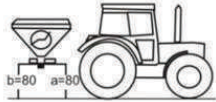

N 32 Zaksan

Grupa Azoty Zakłady Azotowe Kędzierzyn S.A.

Formuła nawozu: N 32
Klasa ziarnowa: granule 2-5 mm, nie mniej niż 95%
Gęstość nasypowa: 0,98-1,0 kg/dm³

Szerokość robocza	12 m						15 m						16 m						18 m					
Typ i ustawienie lopatek	LD I - 1,5						LD I - 1,5						LD I - 2,2						LD I - 2,5					
	LK I - 2						LK I - 2,2						LK I - 2,2						LK I - 2,2					
Obroty	540 obr/min						540 obr/min						540 obr/min						540 obr/min					
Dawka wysiewu	kg/ha																							
Nastawa	Prędk. robocza [km/h]						Prędk. robocza [km/h]						Prędk. robocza [km/h]						Prędk. robocza [km/h]					
	6	8	10	12	14	16	6	8	10	12	14	16	6	8	10	12	14	16	6	8	10	12	14	16
4	61	46	37	31	26	23	49	37	29	24	21	18	46	34	27	23	20	17	41	31	24	20	17	15
4,5	77	58	46	38	33	29	61	46	37	31	26	23	58	43	35	29	25	22	51	38	31	26	22	19
5	92	69	55	46	40	35	74	55	44	37	32	28	69	52	42	35	30	26	62	46	37	31	26	23
5,5	113	85	68	57	49	43	91	68	54	45	39	34	85	64	51	43	36	32	76	57	45	38	32	28
6	137	103	82	69	59	51	110	82	66	55	47	41	103	77	62	51	44	39	92	69	55	46	39	34
6,5	161	121	97	81	69	60	129	97	77	64	55	48	121	91	72	60	52	45	107	81	64	54	46	40
7	198	149	119	99	85	74	159	119	95	79	68	59	149	111	89	74	64	56	132	99	79	66	57	50
7,5	234	176	141	117	100	88	187	141	112	94	80	70	176	132	105	88	75	66	156	117	94	78	67	59
8	267	200	160	133	114	100	214	160	128	107	92	80	200	150	120	100	86	75	178	133	107	89	76	67
8,5	307	230	184	154	132	115	246	184	147	123	105	92	230	173	138	115	99	86	205	154	123	102	88	77
9	352	264	211	176	151	132	282	211	169	141	121	106	264	198	158	132	113	99	235	176	141	117	101	88
9,5	404	303	243	202	173	152	323	243	194	162	139	121	303	227	182	152	130	114	269	202	162	135	115	101
10	456	342	274	228	195	171	365	274	219	182	156	137	342	257	205	171	147	128	304	228	182	152	130	114
10,5	525	394	315	262	225	197	420	315	252	210	180	157	394	295	236	197	169	148	350	262	210	175	150	131
11	581	436	348	290	249	218	465	348	279	232	199	174	436	327	261	218	187	163	387	290	232	194	166	145
11,5	648	486	389	324	278	243	519	389	311	259	222	195	486	365	292	243	208	182	432	324	259	216	185	162
12	730	548	438	365	313	274	584	438	351	292	250	219	548	411	329	274	235	205	487	365	292	243	209	183
12,5	805	604	483	402	345	302	644	483	386	322	276	241	604	453	362	302	259	226	537	402	322	268	230	201
13	895	671	537	448	384	336	716	537	430	358	307	269	671	503	403	336	288	252	597	448	358	298	256	224
13,5	985	738	591	492	422	369	788	591	473	394	338	295	738	554	443	369	316	277	656	492	394	328	281	246
14	1091	819	655	546	468	409	873	655	524	437	374	327	819	614	491	409	351	307	728	546	437	364	312	273
14,5	1179	884	707	590	505	442	943	707	566	472	404	354	884	663	531	442	379	332	786	590	472	393	337	295
15	1304	978	782	652	559	489	1043	782	626	521	447	391	978	733	587	489	419	367	869	652	521	435	372	326
15,5	1394	1045	836	697	597	523	1115	836	669	558	478	418	1045	784	627	523	448	392	929	697	558	465	398	348
16	1560	1170	936	780	669	585	1248	936	749	624	535	468	1170	878	702	585	502	439	1040	780	624	520	446	390
16,5	1660	1245	996	830	712	623	1328	996	797	664	569	498	1245	934	747	623	534	467	1107	830	664	553	474	415
17	1836	1377	1102	918	787	689	1469	1102	881	735	630	551	1377	1033	826	689	590	516	1224	918	735	612	525	459
17,5	1893	1420	1136	947	811	710	1515	1136	909	757	649	568	1420	1065	852	710	609	533	1262	947	757	631	541	473
18	2028	1521	1217	1014	869	761	1623	1217	974	811	695	608	1521	1141	913	761	652	570	1352	1014	811	676	579	507
18,5	2051	1539	1231	1026	879	769	1641	1231	985	821	703	615	1539	1154	923	769	659	577	1368	1026	821	684	586	513

LD 0 - Lopatka 0 długa
LD I - Lopatka I długa
LK 0 - Lopatka 0 krótka
LK I - Lopatka I krótka



Tabela wysiewu

SIPMA RN 610 ANTEK

Tarcza: 430

Lopatki I



N 32 Zaksan

Grupa Azoty Zakłady Azotowe Kędzierzyn S.A.

Formuła nawozu: N 32
Klasa ziarnowa: granulę 2-5 mm, nie mniej niż 95%
Gęstość nasypowa: 0,98-1,0 kg/dm³

Szerokość robocza	20 m						21 m						24 m					
Typ i ustawienie lopatek	LD I - 3,1						LD I - 3,2						LD I - 3,4					
	LK I - 2,2						LK I - 2						LK I - 2					
Obroty	540 obr/min						540 obr/min						540 obr/min					
Dawka wysiewu	kg/ha																	
Nastawa	Prędk. robocza [km/h]						Prędk. robocza [km/h]						Prędk. robocza [km/h]					
	6	8	10	12	14	16	6	8	10	12	14	16	6	8	10	12	14	16
4	37	27	22	18	16	14	35	26	21	17	15	13	31	23	18	15	13	11
4,5	46	35	28	23	20	17	44	33	26	22	19	16	38	29	23	19	16	14
5	55	42	33	28	24	21	53	40	32	26	23	20	46	35	28	23	20	17
5,5	68	51	41	34	29	26	65	49	39	32	28	24	57	43	34	28	24	21
6	82	62	49	41	35	31	78	59	47	39	34	29	69	51	41	34	29	26
6,5	97	72	58	48	41	36	92	69	55	46	39	35	81	60	48	40	35	30
7	119	89	71	59	51	45	113	85	68	57	49	42	99	74	59	50	42	37
7,5	141	105	84	70	60	53	134	100	80	67	57	50	117	88	70	59	50	44
8	160	120	96	80	69	60	153	114	92	76	65	57	133	100	80	67	57	50
8,5	184	138	111	92	79	69	175	132	105	88	75	66	154	115	92	77	66	58
9	211	158	127	106	91	79	201	151	121	101	86	75	176	132	106	88	75	66
9,5	243	182	146	121	104	91	231	173	139	115	99	87	202	152	121	101	87	76
10	274	205	164	137	117	103	261	195	156	130	112	98	228	171	137	114	98	86
10,5	315	236	189	157	135	118	300	225	180	150	129	112	262	197	157	131	112	98
11	348	261	209	174	149	131	332	249	199	166	142	124	290	218	174	145	124	109
11,5	389	292	233	195	167	146	371	278	222	185	159	139	324	243	195	162	139	122
12	438	329	263	219	188	164	417	313	250	209	179	157	365	274	219	183	157	137
12,5	483	362	290	241	207	181	460	345	276	230	197	172	402	302	241	201	172	151
13	537	403	322	269	230	201	511	384	307	256	219	192	448	336	269	224	192	168
13,5	591	443	354	295	253	222	563	422	338	281	241	211	492	369	295	246	211	185
14	655	491	393	327	281	246	624	468	374	312	267	234	546	409	327	273	234	205
14,5	707	531	424	354	303	265	674	505	404	337	289	253	590	442	354	295	253	221
15	782	587	469	391	335	293	745	559	447	372	319	279	652	489	391	326	279	244
15,5	836	627	502	418	358	314	796	597	478	398	341	299	697	523	418	348	299	261
16	936	702	562	468	401	351	892	669	535	446	382	334	780	585	468	390	334	293
16,5	996	747	598	498	427	374	949	712	569	474	407	356	830	623	498	415	356	311
17	1102	826	661	551	472	413	1049	787	630	525	450	394	918	689	551	459	394	344
17,5	1136	852	682	568	487	426	1082	811	649	541	464	406	947	710	568	473	406	355
18	1217	913	730	608	522	456	1159	869	695	579	497	435	1014	761	608	507	435	380
18,5	1231	923	739	615	528	462	1172	879	703	586	502	440	1026	769	615	513	440	385

LD 0 - Lopatka 0 długa
LD I - Lopatka I długa
LK 0 - Lopatka 0 krótka
LK I - Lopatka I krótka



Tabela wysiewu

SIPMA RN 610 ANTEK

Tarcza: 430

Lopatkki 0



N 27,5 Salmag

Grupa Azoty Zakłady Azotowe Kędzierzyn S.A.

Formuła nawozu: N(CaMg) 27,5-(3,5-4)
Klasa ziarnowa: granule 2-5 mm, nie mniej niż 95%
Gęstość nasypowa: 1,0 kg/dm³

Szerokość robocza	10 m						15 m						16 m						18 m						20 m					
Typ i ustawienie lopatek	LD 0 - 1,4						LD 0 - 2						LD 0 - 2,2						LD 0 - 2,4						LD 0 - 3					
	LK 0 - 0,4						LK 0 - 1,4						LK 0 - 2,2						LK 0 - 2,2						LK 0 - 2,2					
Obroty	540 obr/min						540 obr/min						540 obr/min						540 obr/min						540 obr/min					
Dawka wysiewu	kg/ha																													
Nastawa	Prędk. robocza [km/h]						Prędk. robocza [km/h]						Prędk. robocza [km/h]						Prędk. robocza [km/h]						Prędk. robocza [km/h]					
	6	8	10	12	14	16	6	8	10	12	14	16	6	8	10	12	14	16	6	8	10	12	14	16	6	8	10	12	14	16
4	87	66	52	44	37	33	58	44	35	29	25	22	55	41	33	27	23	20	49	36	29	24	21	18	44	33	26	22	19	16
4,5	108	81	65	54	46	41	72	54	43	36	31	27	68	51	41	34	29	25	60	45	36	30	26	23	54	41	33	27	23	20
5	134	100	80	67	57	50	89	67	54	45	38	33	84	63	50	42	36	31	74	56	45	37	32	28	67	50	40	33	29	25
5,5	160	120	96	80	69	60	107	80	64	53	46	40	100	75	60	50	43	38	89	67	53	45	38	33	80	60	48	40	34	30
6	193	145	116	96	83	72	128	96	77	64	55	48	120	90	72	60	52	45	107	80	64	54	46	40	96	72	58	48	41	36
6,5	232	174	139	116	99	87	154	116	93	77	66	58	145	109	87	72	62	54	129	97	77	64	55	48	116	87	69	58	50	43
7	268	201	161	134	115	100	178	134	107	89	76	67	167	125	100	84	72	63	149	111	89	74	64	56	134	100	80	67	57	50
7,5	315	236	189	157	135	118	210	157	126	105	90	79	197	148	118	98	84	74	175	131	105	87	75	66	157	118	94	79	67	59
8	369	276	221	184	158	138	246	184	147	123	105	92	230	173	138	115	99	86	205	154	123	102	88	77	184	138	111	92	79	69
8,5	424	318	254	212	182	159	283	212	170	141	121	106	265	199	159	132	114	99	236	177	141	118	101	88	212	159	127	106	91	79
9	496	372	298	248	213	186	331	248	198	165	142	124	310	232	186	155	133	116	276	207	165	138	118	103	248	186	149	124	106	93
9,5	551	413	331	275	236	207	367	275	220	184	157	138	344	258	207	172	148	129	306	230	184	153	131	115	275	207	165	138	118	103
10	622	467	373	311	267	233	415	311	249	207	178	156	389	292	233	194	167	146	346	259	207	173	148	130	311	233	187	156	133	117
10,5	703	527	422	351	301	264	469	351	281	234	201	176	439	330	264	220	188	165	391	293	234	195	167	146	351	264	211	176	151	132
11	778	584	467	389	333	292	519	389	311	259	222	195	486	365	292	243	208	182	432	324	259	216	185	162	389	292	233	195	167	146
11,5	872	654	523	436	374	327	582	436	349	291	249	218	545	409	327	273	234	204	485	364	291	242	208	182	436	327	262	218	187	164
12	970	728	582	485	416	364	647	485	388	323	277	243	606	455	364	303	260	227	539	404	323	269	231	202	485	364	291	243	208	182
12,5	1083	812	650	541	464	406	722	541	433	361	309	271	677	508	406	338	290	254	602	451	361	301	258	226	541	406	325	271	232	203
13	1201	901	721	601	515	451	801	601	481	400	343	300	751	563	451	375	322	282	667	501	400	334	286	250	601	451	360	300	257	225
13,5	1322	992	793	661	567	496	881	661	529	441	378	331	826	620	496	413	354	310	734	551	441	367	315	275	661	496	397	331	283	248
14	1449	1087	870	725	621	544	966	725	580	483	414	362	906	679	544	453	388	340	805	604	483	403	345	302	725	544	435	362	311	272
14,5	1573	1180	944	787	674	590	1049	787	629	524	450	393	983	738	590	492	421	369	874	656	524	437	375	328	787	590	472	393	337	295
15	1733	1300	1040	866	743	650	1155	866	693	578	495	433	1083	812	650	542	464	406	963	722	578	481	413	361	866	650	520	433	371	325
15,5	1911	1434	1147	956	819	717	1274	956	765	637	546	478	1195	896	717	597	512	448	1062	796	637	531	455	398	956	717	573	478	410	358
16	2010	1507	1206	1005	861	754	1340	1005	804	670	574	502	1256	942	754	628	538	471	1116	837	670	558	478	419	1005	754	603	502	431	377
16,5	2169	1627	1302	1085	930	813	1446	1085	868	723	620	542	1356	1017	813	678	581	508	1205	904	723	603	516	452	1085	813	651	542	465	407
17	2352	1764	1411	1176	1008	882	1568	1176	941	784	672	588	1470	1103	882	735	630	551	1307	980	784	653	560	490	1176	882	706	588	504	441
17,5	2508	1881	1505	1254	1075	941	1672	1254	1003	836	717	627	1568	1176	941	784	672	588	1394	1045	836	697	597	523	1254	941	753	627	538	470
18	2617	1963	1570	1309	1122	981	1745	1309	1047	872	748	654	1636	1227	981	818	701	613	1454	1091	872	727	623	545	1309	981	785	654	561	491
18,5	2650	1987	1590	1325	1136	994	1766	1325	1060	883	757	662	1656	1242	994	828	710	621	1472	1104	883	736	631	552	1325	994	795	662	568	497

LD 0 - Lopatka 0 długa
LD 1 - Lopatka I długa
LK 0 - Lopatka 0 krótka
LK 1 - Lopatka I krótka



Tabela wysiewu

SIPMA RN 610 ANTEK

Tarcza: 430

Lopatki I



N 27,5 Salmag

Grupa Azoty Zakłady Azotowe Kędzierzyn S.A.

Formuła nawozu: N(CaMg) 27,5-(3,5-4)
Klasa ziarnowa: granule 2-5 mm, nie mniej niż 95%
Gęstość nasypowa: 1,0 kg/dm³

Szerokość robocza	12 m						15 m						16 m						18 m					
Typ i ustawienie lopatek	LD I - 2						LD I - 2,2						LD I - 2,4						LD I - 3					
	LK I - 1,2						LK I - 1,2						LK I - 1,2						LK I - 1,3					
Obroty	540 obr/min						540 obr/min						540 obr/min						540 obr/min					
Dawka wysiewu	kg/ha																							
Nastawa	Prędk. robocza [km/h]						Prędk. robocza [km/h]						Prędk. robocza [km/h]						Prędk. robocza [km/h]					
	6	8	10	12	14	16	6	8	10	12	14	16	6	8	10	12	14	16	6	8	10	12	14	16
4	76	57	46	38	33	29	61	46	37	30	26	23	57	43	34	29	24	21	51	38	30	25	22	19
4,5	88	66	53	44	38	33	70	53	42	35	30	26	66	50	40	33	28	25	59	44	35	29	25	22
5	108	81	65	54	46	41	86	65	52	43	37	32	81	61	49	41	35	30	72	54	43	36	31	27
5,5	130	97	78	65	56	49	104	78	62	52	45	39	97	73	58	49	42	37	87	65	52	43	37	32
6	153	115	92	76	66	57	122	92	73	61	52	46	115	86	69	57	49	43	102	76	61	51	44	38
6,5	192	144	115	96	82	72	153	115	92	77	66	57	144	108	86	72	62	54	128	96	77	64	55	48
7	221	165	132	110	95	83	176	132	106	88	76	66	165	124	99	83	71	62	147	110	88	74	63	55
7,5	262	197	157	131	112	98	210	157	126	105	90	79	197	147	118	98	84	74	175	131	105	87	75	66
8	297	223	178	149	127	111	238	178	143	119	102	89	223	167	134	111	95	84	198	149	119	99	85	74
8,5	346	259	207	173	148	130	277	207	166	138	119	104	259	194	156	130	111	97	231	173	138	115	99	86
9	398	298	239	199	170	149	318	239	191	159	136	119	298	224	179	149	128	112	265	199	159	133	114	99
9,5	456	342	274	228	196	171	365	274	219	183	156	137	342	257	205	171	147	128	304	228	183	152	130	114
10	511	383	306	255	219	191	408	306	245	204	175	153	383	287	230	191	164	144	340	255	204	170	146	128
10,5	580	435	348	290	249	218	464	348	279	232	199	174	435	326	261	218	187	163	387	290	232	193	166	145
11	659	494	395	329	282	247	527	395	316	263	226	198	494	370	296	247	212	185	439	329	263	220	188	165
11,5	731	548	438	365	313	274	585	438	351	292	251	219	548	411	329	274	235	206	487	365	292	244	209	183
12	877	658	526	439	376	329	702	526	421	351	301	263	658	494	395	329	282	247	585	439	351	292	251	219
12,5	944	708	567	472	405	354	755	567	453	378	324	283	708	531	425	354	304	266	630	472	378	315	270	236
13	1048	786	629	524	449	393	838	629	503	419	359	314	786	590	472	393	337	295	699	524	419	349	299	262
13,5	1123	842	674	561	481	421	898	674	539	449	385	337	842	632	505	421	361	316	749	561	449	374	321	281
14	1242	932	745	621	532	466	994	745	596	497	426	373	932	699	559	466	399	349	828	621	497	414	355	311
14,5	1339	1004	803	669	574	502	1071	803	643	535	459	402	1004	753	602	502	430	377	892	669	535	446	382	335
15	1485	1114	891	743	637	557	1188	891	713	594	509	446	1114	835	668	557	477	418	990	743	594	495	424	371
15,5	1582	1186	949	791	678	593	1265	949	759	633	542	475	1186	890	712	593	508	445	1054	791	633	527	452	395
16	1790	1342	1074	895	767	671	1432	1074	859	716	614	537	1342	1007	805	671	575	503	1193	895	716	597	511	447
16,5	1977	1483	1186	989	847	742	1582	1186	949	791	678	593	1483	1112	890	742	636	556	1318	989	791	659	565	494
17	2060	1545	1236	1030	883	773	1648	1236	989	824	706	618	1545	1159	927	773	662	579	1373	1030	824	687	589	515
17,5	2134	1600	1280	1067	915	800	1707	1280	1024	854	732	640	1600	1200	960	800	686	600	1423	1067	854	711	610	533
18	2246	1685	1348	1123	963	842	1797	1348	1078	898	770	674	1685	1263	1011	842	722	632	1497	1123	898	749	642	562
18,5	2280	1710	1368	1140	977	855	1824	1368	1094	912	782	684	1710	1283	1026	855	733	641	1520	1140	912	760	651	570

LD 0 - Lopatka 0 długa
LD I - Lopatka I długa
LK 0 - Lopatka 0 krótka
LK I - Lopatka I krótka



Tabela wysiewu

SIPMA RN 610 ANTEK

Tarcza: 430

Lopatki I



N 27,5 Salmag

Grupa Azoty Zakłady Azotowe Kędzierzyn S.A.

Formuła nawozu: N(CaMg) 27,5-(3,5-4)
Klasa ziarnowa: granulę 2-5 mm, nie mniej niż 95%
Gęstość nasypowa: 1,0 kg/dm³

Szerokość robocza	20 m						21 m						24 m					
Typ i ustawienie lopatek	LD I - 3,1						LD I - 3,1						LD I - 3,1					
	LK I - 1,3						LK I - 2						LK I - 2,2					
Obroty	540 obr/min						540 obr/min						540 obr/min					
Dawka wysiewu	kg/ha																	
Nastawa	Prędk. robocza [km/h]						Prędk. robocza [km/h]						Prędk. robocza [km/h]					
	6	8	10	12	14	16	6	8	10	12	14	16	6	8	10	12	14	16
4	46	34	27	23	20	17	43	33	26	22	19	16	38	29	23	19	16	14
4,5	53	40	32	26	23	20	50	38	30	25	22	19	44	33	26	22	19	17
5	65	49	39	32	28	24	62	46	37	31	26	23	54	41	32	27	23	20
5,5	78	58	47	39	33	29	74	56	45	37	32	28	65	49	39	32	28	24
6	92	69	55	46	39	34	87	66	52	44	37	33	76	57	46	38	33	29
6,5	115	86	69	57	49	43	109	82	66	55	47	41	96	72	57	48	41	36
7	132	99	79	66	57	50	126	95	76	63	54	47	110	83	66	55	47	41
7,5	157	118	94	79	67	59	150	112	90	75	64	56	131	98	79	66	56	49
8	178	134	107	89	76	67	170	127	102	85	73	64	149	111	89	74	64	56
8,5	207	156	124	104	89	78	198	148	119	99	85	74	173	130	104	86	74	65
9	239	179	143	119	102	89	227	170	136	114	97	85	199	149	119	99	85	75
9,5	274	205	164	137	117	103	261	196	156	130	112	98	228	171	137	114	98	86
10	306	230	184	153	131	115	292	219	175	146	125	109	255	191	153	128	109	96
10,5	348	261	209	174	149	131	332	249	199	166	142	124	290	218	174	145	124	109
11	395	296	237	198	169	148	376	282	226	188	161	141	329	247	198	165	141	123
11,5	438	329	263	219	188	164	418	313	251	209	179	157	365	274	219	183	157	137
12	526	395	316	263	226	197	501	376	301	251	215	188	439	329	263	219	188	165
12,5	567	425	340	283	243	212	540	405	324	270	231	202	472	354	283	236	202	177
13	629	472	377	314	269	236	599	449	359	299	257	225	524	393	314	262	225	197
13,5	674	505	404	337	289	253	642	481	385	321	275	241	561	421	337	281	241	211
14	745	559	447	373	319	279	710	532	426	355	304	266	621	466	373	311	266	233
14,5	803	602	482	402	344	301	765	574	459	382	328	287	669	502	402	335	287	251
15	891	668	535	446	382	334	849	637	509	424	364	318	743	557	446	371	318	278
15,5	949	712	569	475	407	356	904	678	542	452	387	339	791	593	475	395	339	297
16	1074	805	644	537	460	403	1023	767	614	511	438	384	895	671	537	447	384	336
16,5	1186	890	712	593	508	445	1130	847	678	565	484	424	989	742	593	494	424	371
17	1236	927	742	618	530	464	1177	883	706	589	504	441	1030	773	618	515	441	386
17,5	1280	960	768	640	549	480	1219	915	732	610	523	457	1067	800	640	533	457	400
18	1348	1011	809	674	578	505	1283	963	770	642	550	481	1123	842	674	562	481	421
18,5	1368	1026	821	684	586	513	1303	977	782	651	558	489	1140	855	684	570	489	428

LD 0 - Lopatka 0 długa
LD 1 - Lopatka 1 długa
LK 0 - Lopatka 0 krótka
LK 1 - Lopatka 1 krótka



Tabela wysiewu

SIPMA RN 610 ANTEK

Tarcza: 430

Lopatki 0



N 27,5 Salmag z siarką

Grupa Azoty Zakłady Azotowe Kędzierzyn S.A.

Formuła nawozu: N(CaS) 27,5-(6,5-4,5)
Klasa ziarnowa: granule 2-5 mm, nie mniej niż 95%
Gęstość nasypowa: 1,1 kg/dm³

Szerokość robocza	10 m						12 m						15 m						16 m						18 m					
Typ i ustawienie łopatek	LD 0 - 2,2						LD 0 - 2,4						LD 0 - 3						LD 0 - 3,2						LD 0 - 3,3					
	LK 0 - 1,4						LK 0 - 1,4						LK 0 - 1,4						LK 0 - 2						LK 0 - 2					
Obroty	540 obr/min						540 obr/min						540 obr/min						540 obr/min						540 obr/min					
Dawka wysiewu	kg/ha																													
Nastawa	Prędk. robocza [km/h]						Prędk. robocza [km/h]						Prędk. robocza [km/h]						Prędk. robocza [km/h]						Prędk. robocza [km/h]					
	6	8	10	12	14	16	6	8	10	12	14	16	6	8	10	12	14	16	6	8	10	12	14	16	6	8	10	12	14	16
4	91	68	55	46	39	34	76	57	46	38	33	29	61	46	37	30	26	23	57	43	34	29	24	21	51	38	30	25	22	19
4,5	106	79	63	53	45	40	88	66	53	44	38	33	70	53	42	35	30	26	66	50	40	33	28	25	59	44	35	29	25	22
5	130	97	78	65	56	49	108	81	65	54	46	41	86	65	52	43	37	32	81	61	49	41	35	30	72	54	43	36	31	27
5,5	156	117	94	78	67	58	130	97	78	65	56	49	104	78	62	52	45	39	97	73	58	49	42	37	87	65	52	43	37	32
6	183	138	110	92	79	69	153	115	92	76	66	57	122	92	73	61	52	46	115	86	69	57	49	43	102	76	61	51	44	38
6,5	230	172	138	115	99	86	192	144	115	96	82	72	153	115	92	77	66	57	144	108	86	72	62	54	128	96	77	64	55	48
7	265	199	159	132	113	99	221	165	132	110	95	83	176	132	106	88	76	66	165	124	99	83	71	62	147	110	88	74	63	55
7,5	314	236	189	157	135	118	262	197	157	131	112	98	210	157	126	105	90	79	197	147	118	98	84	74	175	131	105	87	75	66
8	356	267	214	178	153	134	297	223	178	149	127	111	238	178	143	119	102	89	223	167	134	111	95	84	198	149	119	99	85	74
8,5	415	311	249	207	178	156	346	259	207	173	148	130	277	207	166	138	119	104	259	194	156	130	111	97	231	173	138	115	99	86
9	477	358	286	239	205	179	398	298	239	199	170	149	318	239	191	159	136	119	298	224	179	149	128	112	265	199	159	133	114	99
9,5	548	411	329	274	235	205	456	342	274	228	196	171	365	274	219	183	156	137	342	257	205	171	147	128	304	228	183	152	130	114
10	613	460	368	306	263	230	511	383	306	255	219	191	408	306	245	204	175	153	383	287	230	191	164	144	340	255	204	170	146	128
10,5	696	522	418	348	298	261	580	435	348	290	249	218	464	348	279	232	199	174	435	326	261	218	187	163	387	290	232	193	166	145
11	790	593	474	395	339	296	659	494	395	329	282	247	527	395	316	263	226	198	494	370	296	247	212	185	439	329	263	220	188	165
11,5	877	658	526	438	376	329	731	548	438	365	313	274	585	438	351	292	251	219	548	411	329	274	235	206	487	365	292	244	209	183
12	1053	790	632	526	451	395	877	658	526	439	376	329	702	526	421	351	301	263	658	494	395	329	282	247	585	439	351	292	251	219
12,5	1133	850	680	567	486	425	944	708	567	472	405	354	755	567	453	378	324	283	708	531	425	354	304	266	630	472	378	315	270	236
13	1258	943	755	629	539	472	1048	786	629	524	449	393	838	629	503	419	359	314	786	590	472	393	337	295	699	524	419	349	299	262
13,5	1347	1011	808	674	577	505	1123	842	674	561	481	421	898	674	539	449	385	337	842	632	505	421	361	316	749	561	449	374	321	281
14	1490	1118	894	745	639	559	1242	932	745	621	532	466	994	745	596	497	426	373	932	699	559	466	399	349	828	621	497	414	355	311
14,5	1606	1205	964	803	688	602	1339	1004	803	669	574	502	1071	803	643	535	459	402	1004	753	602	502	430	377	892	669	535	446	382	335
15	1782	1337	1069	891	764	668	1485	1114	891	743	637	557	1188	891	713	594	509	446	1114	835	668	557	477	418	990	743	594	495	424	371
15,5	1898	1424	1139	949	813	712	1582	1186	949	791	678	593	1265	949	759	633	542	475	1186	890	712	593	508	445	1054	791	633	527	452	395
16	2148	1611	1289	1074	920	805	1790	1342	1074	895	767	671	1432	1074	859	716	614	537	1342	1007	805	671	575	503	1193	895	716	597	511	447
16,5	2373	1780	1424	1186	1017	890	1977	1483	1186	989	847	742	1582	1186	949	791	678	593	1483	1112	890	742	636	556	1318	989	791	659	565	494
17	2472	1854	1483	1236	1059	927	2060	1545	1236	1030	883	773	1648	1236	989	824	706	618	1545	1159	927	773	662	579	1373	1030	824	687	589	515
17,5	2561	1920	1536	1280	1097	960	2134	1600	1280	1067	915	800	1707	1280	1024	854	732	640	1600	1200	960	800	686	600	1423	1067	854	711	610	533
18	2695	2021	1617	1348	1155	1011	2246	1685	1348	1123	963	842	1797	1348	1078	898	770	674	1685	1263	1011	842	722	632	1497	1123	898	749	642	562
18,5	2736	2052	1642	1368	1173	1026	2280	1710	1368	1140	977	855	1824	1368	1094	912	782	684	1710	1283	1026	855	733	641	1520	1140	912	760	651	570

LD 0 - Lopatka 0 długa
LD 1 - Lopatka I długa
LK 0 - Lopatka 0 krótka
LK 1 - Lopatka I krótka



Tabela wysiewu

SIPMA RN 610 ANTEK

Tarcza: 430

Lopatki I

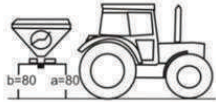

N 27,5 Salmag z siarką

Grupa Azoty Zakłady Azotowe Kędzierzyn S.A.

Formuła nawozu: N(CaS) 27,5-(6,5-4,5)
Klasa ziarnowa: granule 2-5 mm, nie mniej niż 95%
Gęstość nasypowa: 1,1 kg/dm³

Szerokość robocza	12 m						15 m						16 m						18 m					
Typ i ustawienie lopatek	LD I - 2						LD I - 2,2						LD I - 2,4						LD I - 3					
	LK I - 1,2						LK I - 1,2						LK I - 1,2						LK I - 1,3					
Obroty	540 obr/min						540 obr/min						540 obr/min						540 obr/min					
Dawka wysiewu	kg/ha																							
Nastawa	Prędk. robocza [km/h]						Prędk. robocza [km/h]						Prędk. robocza [km/h]						Prędk. robocza [km/h]					
	6	8	10	12	14	16	6	8	10	12	14	16	6	8	10	12	14	16	6	8	10	12	14	16
4	76	57	46	38	33	29	61	46	37	30	26	23	57	43	34	29	24	21	51	38	30	25	22	19
4,5	88	66	53	44	38	33	70	53	42	35	30	26	66	50	40	33	28	25	59	44	35	29	25	22
5	108	81	65	54	46	41	86	65	52	43	37	32	81	61	49	41	35	30	72	54	43	36	31	27
5,5	130	97	78	65	56	49	104	78	62	52	45	39	97	73	58	49	42	37	87	65	52	43	37	32
6	153	115	92	76	66	57	122	92	73	61	52	46	115	86	69	57	49	43	102	76	61	51	44	38
6,5	192	144	115	96	82	72	153	115	92	77	66	57	144	108	86	72	62	54	128	96	77	64	55	48
7	221	165	132	110	95	83	176	132	106	88	76	66	165	124	99	83	71	62	147	110	88	74	63	55
7,5	262	197	157	131	112	98	210	157	126	105	90	79	197	147	118	98	84	74	175	131	105	87	75	66
8	297	223	178	149	127	111	238	178	143	119	102	89	223	167	134	111	95	84	198	149	119	99	85	74
8,5	346	259	207	173	148	130	277	207	166	138	119	104	259	194	156	130	111	97	231	173	138	115	99	86
9	398	298	239	199	170	149	318	239	191	159	136	119	298	224	179	149	128	112	265	199	159	133	114	99
9,5	456	342	274	228	196	171	365	274	219	183	156	137	342	257	205	171	147	128	304	228	183	152	130	114
10	511	383	306	255	219	191	408	306	245	204	175	153	383	287	230	191	164	144	340	255	204	170	146	128
10,5	580	435	348	290	249	218	464	348	279	232	199	174	435	326	261	218	187	163	387	290	232	193	166	145
11	659	494	395	329	282	247	527	395	316	263	226	198	494	370	296	247	212	185	439	329	263	220	188	165
11,5	731	548	438	365	313	274	585	438	351	292	251	219	548	411	329	274	235	206	487	365	292	244	209	183
12	877	658	526	439	376	329	702	526	421	351	301	263	658	494	395	329	282	247	585	439	351	292	251	219
12,5	944	708	567	472	405	354	755	567	453	378	324	283	708	531	425	354	304	266	630	472	378	315	270	236
13	1048	786	629	524	449	393	838	629	503	419	359	314	786	590	472	393	337	295	699	524	419	349	299	262
13,5	1123	842	674	561	481	421	898	674	539	449	385	337	842	632	505	421	361	316	749	561	449	374	321	281
14	1242	932	745	621	532	466	994	745	596	497	426	373	932	699	559	466	399	349	828	621	497	414	355	311
14,5	1339	1004	803	669	574	502	1071	803	643	535	459	402	1004	753	602	502	430	377	892	669	535	446	382	335
15	1485	1114	891	743	637	557	1188	891	713	594	509	446	1114	835	668	557	477	418	990	743	594	495	424	371
15,5	1582	1186	949	791	678	593	1265	949	759	633	542	475	1186	890	712	593	508	445	1054	791	633	527	452	395
16	1790	1342	1074	895	767	671	1432	1074	859	716	614	537	1342	1007	805	671	575	503	1193	895	716	597	511	447
16,5	1977	1483	1186	989	847	742	1582	1186	949	791	678	593	1483	1112	890	742	636	556	1318	989	791	659	565	494
17	2060	1545	1236	1030	883	773	1648	1236	989	824	706	618	1545	1159	927	773	662	579	1373	1030	824	687	589	515
17,5	2134	1600	1280	1067	915	800	1707	1280	1024	854	732	640	1600	1200	960	800	686	600	1423	1067	854	711	610	533
18	2246	1685	1348	1123	963	842	1797	1348	1078	898	770	674	1685	1263	1011	842	722	632	1497	1123	898	749	642	562
18,5	2280	1710	1368	1140	977	855	1824	1368	1094	912	782	684	1710	1283	1026	855	733	641	1520	1140	912	760	651	570

LD 0 - Lopatka 0 długa
LD I - Lopatka I długa
LK 0 - Lopatka 0 krótka
LK I - Lopatka I krótka



Tabela wysiewu

SIPMA RN 610 ANTEK

Tarcza: 430

Lopatki I



N 27,5 Salmag z siarką

Grupa Azoty Zakłady Azotowe Kędzierzyn S.A.

Formuła nawozu: N(CaS) 27,5-(6,5-4,5)
Klasa ziarnowa: granulę 2-5 mm, nie mniej niż 95%
Gęstość nasypowa: 1,1 kg/dm³

Szerokość robocza	20 m						21 m						24 m					
Typ i ustawienie lopatek	LD I - 3,1						LD I - 3,1						LD I - 3,1					
	LK I - 1,3						LK I - 2						LK I - 2,2					
Obroty	540 obr/min						540 obr/min						540 obr/min					
Dawka wysiewu	kg/ha																	
Nastawa	Prędk. robocza [km/h]						Prędk. robocza [km/h]						Prędk. robocza [km/h]					
	6	8	10	12	14	16	6	8	10	12	14	16	6	8	10	12	14	16
4	46	34	27	23	20	17	43	33	26	22	19	16	38	29	23	19	16	14
4,5	53	40	32	26	23	20	50	38	30	25	22	19	44	33	26	22	19	17
5	65	49	39	32	28	24	62	46	37	31	26	23	54	41	32	27	23	20
5,5	78	58	47	39	33	29	74	56	45	37	32	28	65	49	39	32	28	24
6	92	69	55	46	39	34	87	66	52	44	37	33	76	57	46	38	33	29
6,5	115	86	69	57	49	43	109	82	66	55	47	41	96	72	57	48	41	36
7	132	99	79	66	57	50	126	95	76	63	54	47	110	83	66	55	47	41
7,5	157	118	94	79	67	59	150	112	90	75	64	56	131	98	79	66	56	49
8	178	134	107	89	76	67	170	127	102	85	73	64	149	111	89	74	64	56
8,5	207	156	124	104	89	78	198	148	119	99	85	74	173	130	104	86	74	65
9	239	179	143	119	102	89	227	170	136	114	97	85	199	149	119	99	85	75
9,5	274	205	164	137	117	103	261	196	156	130	112	98	228	171	137	114	98	86
10	306	230	184	153	131	115	292	219	175	146	125	109	255	191	153	128	109	96
10,5	348	261	209	174	149	131	332	249	199	166	142	124	290	218	174	145	124	109
11	395	296	237	198	169	148	376	282	226	188	161	141	329	247	198	165	141	123
11,5	438	329	263	219	188	164	418	313	251	209	179	157	365	274	219	183	157	137
12	526	395	316	263	226	197	501	376	301	251	215	188	439	329	263	219	188	165
12,5	567	425	340	283	243	212	540	405	324	270	231	202	472	354	283	236	202	177
13	629	472	377	314	269	236	599	449	359	299	257	225	524	393	314	262	225	197
13,5	674	505	404	337	289	253	642	481	385	321	275	241	561	421	337	281	241	211
14	745	559	447	373	319	279	710	532	426	355	304	266	621	466	373	311	266	233
14,5	803	602	482	402	344	301	765	574	459	382	328	287	669	502	402	335	287	251
15	891	668	535	446	382	334	849	637	509	424	364	318	743	557	446	371	318	278
15,5	949	712	569	475	407	356	904	678	542	452	387	339	791	593	475	395	339	297
16	1074	805	644	537	460	403	1023	767	614	511	438	384	895	671	537	447	384	336
16,5	1186	890	712	593	508	445	1130	847	678	565	484	424	989	742	593	494	424	371
17	1236	927	742	618	530	464	1177	883	706	589	504	441	1030	773	618	515	441	386
17,5	1280	960	768	640	549	480	1219	915	732	610	523	457	1067	800	640	533	457	400
18	1348	1011	809	674	578	505	1283	963	770	642	550	481	1123	842	674	562	481	421
18,5	1368	1026	821	684	586	513	1303	977	782	651	558	489	1140	855	684	570	489	428

LD 0 - Lopatka 0 długa
LD 1 - Lopatka 1 długa
LK 0 - Lopatka 0 krótka
LK 1 - Lopatka 1 krótka



Tabela wysiewu

SIPMA RN 610 ANTEK

Tarcza: 430

Lopatkki 0



NPK 4 - 16 - 18 Amofoska

Gdańskie Zakłady Nawozów Fosforowych "Fosfory" Sp. z o.o.

Formuła nawozu: NPK 4-16-18
Klasa ziarnowa: frakcja 2-5,5mm, nie mniej niż 90%
Gęstość nasypowa: 1,15 kg/dm³

Szerokość robocza	10 m						12 m						15 m						16 m						18 m					
Typ i ustawienie lopatek	LD 0 - 0,4						LD 0 - 2						LD 0 - 2,5						LD 0 - 3,2						LD 0 - 3,4					
	LK 0 - 1,4						LK 0 - 2						LK 0 - 2						LK 0 - 2,2						LK 0 - 2,2					
Obroty	540 obr/min						540 obr/min						540 obr/min						540 obr/min						540 obr/min					
Dawka wysiewu	kg/ha																													
Nastawa	Prędk. robocza [km/h]						Prędk. robocza [km/h]						Prędk. robocza [km/h]						Prędk. robocza [km/h]						Prędk. robocza [km/h]					
	6	8	10	12	14	16	6	8	10	12	14	16	6	8	10	12	14	16	6	8	10	12	14	16	6	8	10	12	14	16
4	66	50	40	33	28	25	55	41	33	28	24	21	44	33	27	22	19	17	41	31	25	21	18	16	37	28	22	18	16	14
4,5	81	61	49	40	35	30	67	51	40	34	29	25	54	40	32	27	23	20	51	38	30	25	22	19	45	34	27	22	19	17
5	100	75	60	50	43	38	84	63	50	42	36	31	67	50	40	33	29	25	63	47	38	31	27	24	56	42	33	28	24	21
5,5	124	93	74	62	53	47	103	78	62	52	44	39	83	62	50	41	35	31	78	58	47	39	33	29	69	52	41	34	30	26
6	150	112	90	75	64	56	125	94	75	62	53	47	100	75	60	50	43	37	94	70	56	47	40	35	83	62	50	42	36	31
6,5	180	135	108	90	77	67	150	112	90	75	64	56	120	90	72	60	51	45	112	84	67	56	48	42	100	75	60	50	43	37
7	218	163	131	109	93	82	181	136	109	91	78	68	145	109	87	73	62	54	136	102	82	68	58	51	121	91	73	60	52	45
7,5	255	192	153	128	109	96	213	160	128	106	91	80	170	128	102	85	73	64	160	120	96	80	68	60	142	106	85	71	61	53
8	309	232	185	154	132	116	257	193	154	129	110	96	206	154	123	103	88	77	193	145	116	96	83	72	171	129	103	86	73	64
8,5	354	265	212	177	152	133	295	221	177	147	126	111	236	177	142	118	101	88	221	166	133	111	95	83	197	147	118	98	84	74
9	410	308	246	205	176	154	342	256	205	171	146	128	273	205	164	137	117	103	256	192	154	128	110	96	228	171	137	114	98	85
9,5	467	350	280	234	200	175	389	292	234	195	167	146	311	234	187	156	133	117	292	219	175	146	125	109	260	195	156	130	111	97
10	536	402	321	268	230	201	446	335	268	223	191	167	357	268	214	179	153	134	335	251	201	167	143	126	298	223	179	149	128	112
10,5	609	457	366	305	261	229	508	381	305	254	218	190	406	305	244	203	174	152	381	286	229	190	163	143	339	254	203	169	145	127
11	687	516	412	344	295	258	573	430	344	286	246	215	458	344	275	229	196	172	430	322	258	215	184	161	382	286	229	191	164	143
11,5	780	585	468	390	334	292	650	487	390	325	279	244	520	390	312	260	223	195	487	366	292	244	209	183	433	325	260	217	186	162
12	864	648	518	432	370	324	720	540	432	360	309	270	576	432	346	288	247	216	540	405	324	270	231	203	480	360	288	240	206	180
12,5	973	729	584	486	417	365	810	608	486	405	347	304	648	486	389	324	278	243	608	456	365	304	261	228	540	405	324	270	232	203
13	1105	829	663	552	474	414	921	691	552	460	395	345	737	552	442	368	316	276	691	518	414	345	296	259	614	460	368	307	263	230
13,5	1208	906	725	604	518	453	1006	755	604	503	431	377	805	604	483	403	345	302	755	566	453	377	323	283	671	503	403	335	288	252
14	1332	999	799	666	571	499	1110	832	666	555	476	416	888	666	533	444	380	333	832	624	499	416	357	312	740	555	444	370	317	277
14,5	1457	1093	874	729	624	546	1214	911	729	607	520	455	971	729	583	486	416	364	911	683	546	455	390	341	809	607	486	405	347	304
15	1603	1202	962	801	687	601	1336	1002	801	668	572	501	1069	801	641	534	458	401	1002	751	601	501	429	376	890	668	534	445	382	334
15,5	1738	1303	1043	869	745	652	1448	1086	869	724	621	543	1159	869	695	579	497	434	1086	815	652	543	465	407	965	724	579	483	414	362
16	1892	1419	1135	946	811	709	1576	1182	946	788	676	591	1261	946	757	631	540	473	1182	887	709	591	507	443	1051	788	631	525	450	394
16,5	2102	1576	1261	1051	901	788	1751	1314	1051	876	751	657	1401	1051	841	701	600	525	1314	985	788	657	563	493	1168	876	701	584	500	438
17	2244	1683	1347	1122	962	842	1870	1403	1122	935	802	701	1496	1122	898	748	641	561	1403	1052	842	701	601	526	1247	935	748	623	534	468
17,5	2372	1779	1423	1186	1016	889	1977	1482	1186	988	847	741	1581	1186	949	791	678	593	1482	1112	889	741	635	556	1318	988	791	659	565	494
18	2435	1826	1461	1218	1044	913	2029	1522	1218	1015	870	761	1623	1218	974	812	696	609	1522	1142	913	761	652	571	1353	1015	812	676	580	507
18,5	2501	1876	1500	1250	1072	938	2084	1563	1250	1042	893	781	1667	1250	1000	834	714	625	1563	1172	938	781	670	586	1389	1042	834	695	595	521

LD 0 - Lopatka 0 długa
LD 1 - Lopatka I długa
LK 0 - Lopatka 0 krótka
LK 1 - Lopatka I krótka



Tabela wysiewu

SIPMA RN 610 ANTEK

Tarcza: 430

Lopatki I



NPK 4 - 16 - 18 Amofoska

Gdańskie Zakłady Nawozów Fosforowych "Fosfory" Sp. z o.o.

Formuła nawozu: NPK 4-16-18
Klasa ziarnowa: frakcja 2-5,5mm, nie mniej niż 90%
Gęstość nasypowa: 1,15 kg/dm³

Szerokość robocza	12 m						15 m						16 m						18 m					
Typ i ustawienie lopatek	LD I - 0,4						LD I - 0,4						LD I - 0,5						LD I - 1,2					
	LK I - 1,3						LK I - 1,4						LK I - 2						LK I - 2					
Obroty	540 obr/min						540 obr/min						540 obr/min						540 obr/min					
Dawka wysiewu	kg/ha																							
Nastawa	Prędk. robocza [km/h]						Prędk. robocza [km/h]						Prędk. robocza [km/h]						Prędk. robocza [km/h]					
	6	8	10	12	14	16	6	8	10	12	14	16	6	8	10	12	14	16	6	8	10	12	14	16
4	55	41	33	28	24	21	44	33	27	22	19	17	41	31	25	21	18	16	37	28	22	18	16	14
4,5	67	51	40	34	29	25	54	40	32	27	23	20	51	38	30	25	22	19	45	34	27	22	19	17
5	84	63	50	42	36	31	67	50	40	33	29	25	63	47	38	31	27	24	56	42	33	28	24	21
5,5	103	78	62	52	44	39	83	62	50	41	35	31	78	58	47	39	33	29	69	52	41	34	30	26
6	125	94	75	62	53	47	100	75	60	50	43	37	94	70	56	47	40	35	83	62	50	42	36	31
6,5	150	112	90	75	64	56	120	90	72	60	51	45	112	84	67	56	48	42	100	75	60	50	43	37
7	181	136	109	91	78	68	145	109	87	73	62	54	136	102	82	68	58	51	121	91	73	60	52	45
7,5	213	160	128	106	91	80	170	128	102	85	73	64	160	120	96	80	68	60	142	106	85	71	61	53
8	257	193	154	129	110	96	206	154	123	103	88	77	193	145	116	96	83	72	171	129	103	86	73	64
8,5	295	221	177	147	126	111	236	177	142	118	101	88	221	166	133	111	95	83	197	147	118	98	84	74
9	342	256	205	171	146	128	273	205	164	137	117	103	256	192	154	128	110	96	228	171	137	114	98	85
9,5	389	292	234	195	167	146	311	234	187	156	133	117	292	219	175	146	125	109	260	195	156	130	111	97
10	446	335	268	223	191	167	357	268	214	179	153	134	335	251	201	167	143	126	298	223	179	149	128	112
10,5	508	381	305	254	218	190	406	305	244	203	174	152	381	286	229	190	163	143	339	254	203	169	145	127
11	573	430	344	286	246	215	458	344	275	229	196	172	430	322	258	215	184	161	382	286	229	191	164	143
11,5	650	487	390	325	279	244	520	390	312	260	223	195	487	366	292	244	209	183	433	325	260	217	186	162
12	720	540	432	360	309	270	576	432	346	288	247	216	540	405	324	270	231	203	480	360	288	240	206	180
12,5	810	608	486	405	347	304	648	486	389	324	278	243	608	456	365	304	261	228	540	405	324	270	232	203
13	921	691	552	460	395	345	737	552	442	368	316	276	691	518	414	345	296	259	614	460	368	307	263	230
13,5	1006	755	604	503	431	377	805	604	483	403	345	302	755	566	453	377	323	283	671	503	403	335	288	252
14	1110	832	666	555	476	416	888	666	533	444	380	333	832	624	499	416	357	312	740	555	444	370	317	277
14,5	1214	911	729	607	520	455	971	729	583	486	416	364	911	683	546	455	390	341	809	607	486	405	347	304
15	1336	1002	801	668	572	501	1069	801	641	534	458	401	1002	751	601	501	429	376	890	668	534	445	382	334
15,5	1448	1086	869	724	621	543	1159	869	695	579	497	434	1086	815	652	543	465	407	965	724	579	483	414	362
16	1576	1182	946	788	676	591	1261	946	757	631	540	473	1182	887	709	591	507	443	1051	788	631	525	450	394
16,5	1751	1314	1051	876	751	657	1401	1051	841	701	600	525	1314	985	788	657	563	493	1168	876	701	584	500	438
17	1870	1403	1122	935	802	701	1496	1122	898	748	641	561	1403	1052	842	701	601	526	1247	935	748	623	534	468
17,5	1977	1482	1186	988	847	741	1581	1186	949	791	678	593	1482	1112	889	741	635	556	1318	988	791	659	565	494
18	2029	1522	1218	1015	870	761	1623	1218	974	812	696	609	1522	1142	913	761	652	571	1353	1015	812	676	580	507
18,5	2080	1560	1248	1040	891	780	1664	1248	998	832	713	624	1560	1170	936	780	668	585	1386	1040	832	693	594	520

LD 0 - Lopatka 0 długa
LD I - Lopatka I długa
LK 0 - Lopatka 0 krótka
LK I - Lopatka I krótka



Tabela wysiewu

SIPMA RN 610 ANTEK

Tarcza: 430

Lopatki I



NPK 4 - 16 - 18 Amofoska

Gdańskie Zakłady Nawozów Fosforowych "Fosfory" Sp. z o.o.

Formuła nawozu: NPK 4-16-18
Klasa ziarnowa: frakcja 2-5,5mm, nie mniej niż 90%
Gęstość nasypowa: 1,15 kg/dm³

Szerokość robocza	20 m						21 m						24 m					
Typ i ustawienie lopatek	LD I - 2,2						LD I - 2,5						LD I - 3					
	LK I - 1,4						LK I - 2						LK I - 2					
Obroty	540 obr/min						540 obr/min						600 obr/min					
Dawka wysiewu	kg/ha																	
Nastawa	Prędk. robocza [km/h]						Prędk. robocza [km/h]						Prędk. robocza [km/h]					
	6	8	10	12	14	16	6	8	10	12	14	16	6	8	10	12	14	16
4	33	25	20	17	14	12	32	24	19	16	14	12	28	21	17	14	12	10
4,5	40	30	24	20	17	15	39	29	23	19	17	14	34	25	20	17	14	13
5	50	38	30	25	22	19	48	36	29	24	20	18	42	31	25	21	18	16
5,5	62	47	37	31	27	23	59	44	35	30	25	22	52	39	31	26	22	19
6	75	56	45	37	32	28	71	53	43	36	31	27	62	47	37	31	27	23
6,5	90	67	54	45	39	34	86	64	51	43	37	32	75	56	45	37	32	28
7	109	82	65	54	47	41	104	78	62	52	44	39	91	68	54	45	39	34
7,5	128	96	77	64	55	48	122	91	73	61	52	46	106	80	64	53	46	40
8	154	116	93	77	66	58	147	110	88	73	63	55	129	96	77	64	55	48
8,5	177	133	106	88	76	66	168	126	101	84	72	63	147	111	88	74	63	55
9	205	154	123	103	88	77	195	146	117	98	84	73	171	128	103	85	73	64
9,5	234	175	140	117	100	88	222	167	133	111	95	83	195	146	117	97	83	73
10	268	201	161	134	115	100	255	191	153	128	109	96	223	167	134	112	96	84
10,5	305	229	183	152	131	114	290	218	174	145	124	109	254	190	152	127	109	95
11	344	258	206	172	147	129	327	246	196	164	140	123	286	215	172	143	123	107
11,5	390	292	234	195	167	146	371	279	223	186	159	139	325	244	195	162	139	122
12	432	324	259	216	185	162	411	309	247	206	176	154	360	270	216	180	154	135
12,5	486	365	292	243	208	182	463	347	278	232	198	174	405	304	243	203	174	152
13	552	414	331	276	237	207	526	395	316	263	225	197	460	345	276	230	197	173
13,5	604	453	362	302	259	226	575	431	345	288	246	216	503	377	302	252	216	189
14	666	499	399	333	285	250	634	476	380	317	272	238	555	416	333	277	238	208
14,5	729	546	437	364	312	273	694	520	416	347	297	260	607	455	364	304	260	228
15	801	601	481	401	343	301	763	572	458	382	327	286	668	501	401	334	286	250
15,5	869	652	521	434	372	326	828	621	497	414	355	310	724	543	434	362	310	272
16	946	709	567	473	405	355	901	676	540	450	386	338	788	591	473	394	338	296
16,5	1051	788	630	525	450	394	1001	751	600	500	429	375	876	657	525	438	375	328
17	1122	842	673	561	481	421	1069	802	641	534	458	401	935	701	561	468	401	351
17,5	1186	889	712	593	508	445	1129	847	678	565	484	424	988	741	593	494	424	371
18	1218	913	731	609	522	457	1160	870	696	580	497	435	1015	761	609	507	435	381
18,5	1248	936	749	624	535	468	1188	891	713	594	509	446	1040	780	624	520	446	390

LD 0 - Lopatka 0 długa
LD 1 - Lopatka 1 długa
LK 0 - Lopatka 0 krótka
LK 1 - Lopatka 1 krótka



Tabela wysiewu

SIPMA RN 610 ANTEK

Tarcza: 430

Lopatki 0



NPK 4 -10 - 22 Amofoska

Gdańskie Zakłady Nawozów Fosforowych "Fosfory" Sp. z o.o.

Formuła nawozu: NPK 4-10-22
Klasa ziarnowa: frakcja 2-5,5 mm, nie mniej niż 90%
Gęstość nasypowa: 1,17 kg/dm³

Szerokość robocza	10 m						12 m						15 m						16 m						18 m					
Typ i ustawienie lopatek	LD 0 - 0,4						LD 0 - 2						LD 0 - 2,5						LD 0 - 3,2						LD 0 - 3,4					
	LK 0 - 1,4						LK 0 - 2						LK 0 - 2						LK 0 - 2,2						LK 0 - 2,2					
Obroty	540 obr/min						540 obr/min						540 obr/min						540 obr/min						540 obr/min					
Dawka wysiewu	kg/ha																													
Nastawa	Prędk. robocza [km/h]						Prędk. robocza [km/h]						Prędk. robocza [km/h]						Prędk. robocza [km/h]						Prędk. robocza [km/h]					
	6	8	10	12	14	16	6	8	10	12	14	16	6	8	10	12	14	16	6	8	10	12	14	16	6	8	10	12	14	16
4	66	50	40	33	28	25	55	41	33	28	24	21	44	33	27	22	19	17	41	31	25	21	18	16	37	28	22	18	16	14
4,5	81	61	49	40	35	30	67	51	40	34	29	25	54	40	32	27	23	20	51	38	30	25	22	19	45	34	27	22	19	17
5	100	75	60	50	43	38	84	63	50	42	36	31	67	50	40	33	29	25	63	47	38	31	27	24	56	42	33	28	24	21
5,5	124	93	74	62	53	47	103	78	62	52	44	39	83	62	50	41	35	31	78	58	47	39	33	29	69	52	41	34	30	26
6	150	112	90	75	64	56	125	94	75	62	53	47	100	75	60	50	43	37	94	70	56	47	40	35	83	62	50	42	36	31
6,5	180	135	108	90	77	67	150	112	90	75	64	56	120	90	72	60	51	45	112	84	67	56	48	42	100	75	60	50	43	37
7	218	163	131	109	93	82	181	136	109	91	78	68	145	109	87	73	62	54	136	102	82	68	58	51	121	91	73	60	52	45
7,5	255	192	153	128	109	96	213	160	128	106	91	80	170	128	102	85	73	64	160	120	96	80	68	60	142	106	85	71	61	53
8	309	232	185	154	132	116	257	193	154	129	110	96	206	154	123	103	88	77	193	145	116	96	83	72	171	129	103	86	73	64
8,5	354	265	212	177	152	133	295	221	177	147	126	111	236	177	142	118	101	88	221	166	133	111	95	83	197	147	118	98	84	74
9	410	308	246	205	176	154	342	256	205	171	146	128	273	205	164	137	117	103	256	192	154	128	110	96	228	171	137	114	98	85
9,5	467	350	280	234	200	175	389	292	234	195	167	146	311	234	187	156	133	117	292	219	175	146	125	109	260	195	156	130	111	97
10	536	402	321	268	230	201	446	335	268	223	191	167	357	268	214	179	153	134	335	251	201	167	143	126	298	223	179	149	128	112
10,5	609	457	366	305	261	229	508	381	305	254	218	190	406	305	244	203	174	152	381	286	229	190	163	143	339	254	203	169	145	127
11	687	516	412	344	295	258	573	430	344	286	246	215	458	344	275	229	196	172	430	322	258	215	184	161	382	286	229	191	164	143
11,5	780	585	468	390	334	292	650	487	390	325	279	244	520	390	312	260	223	195	487	366	292	244	209	183	433	325	260	217	186	162
12	864	648	518	432	370	324	720	540	432	360	309	270	576	432	346	288	247	216	540	405	324	270	231	203	480	360	288	240	206	180
12,5	973	729	584	486	417	365	810	608	486	405	347	304	648	486	389	324	278	243	608	456	365	304	261	228	540	405	324	270	232	203
13	1105	829	663	552	474	414	921	691	552	460	395	345	737	552	442	368	316	276	691	518	414	345	296	259	614	460	368	307	263	230
13,5	1208	906	725	604	518	453	1006	755	604	503	431	377	805	604	483	403	345	302	755	566	453	377	323	283	671	503	403	335	288	252
14	1332	999	799	666	571	499	1110	832	666	555	476	416	888	666	533	444	380	333	832	624	499	416	357	312	740	555	444	370	317	277
14,5	1457	1093	874	729	624	546	1214	911	729	607	520	455	971	729	583	486	416	364	911	683	546	455	390	341	809	607	486	405	347	304
15	1603	1202	962	801	687	601	1336	1002	801	668	572	501	1069	801	641	534	458	401	1002	751	601	501	429	376	890	668	534	445	382	334
15,5	1738	1303	1043	869	745	652	1448	1086	869	724	621	543	1159	869	695	579	497	434	1086	815	652	543	465	407	965	724	579	483	414	362
16	1892	1419	1135	946	811	709	1576	1182	946	788	676	591	1261	946	757	631	540	473	1182	887	709	591	507	443	1051	788	631	525	450	394
16,5	2102	1576	1261	1051	901	788	1751	1314	1051	876	751	657	1401	1051	841	701	600	525	1314	985	788	657	563	493	1168	876	701	584	500	438
17	2244	1683	1347	1122	962	842	1870	1403	1122	935	802	701	1496	1122	898	748	641	561	1403	1052	842	701	601	526	1247	935	748	623	534	468
17,5	2372	1779	1423	1186	1016	889	1977	1482	1186	988	847	741	1581	1186	949	791	678	593	1482	1112	889	741	635	556	1318	988	791	659	565	494
18	2435	1826	1461	1218	1044	913	2029	1522	1218	1015	870	761	1623	1218	974	812	696	609	1522	1142	913	761	652	571	1353	1015	812	676	580	507
18,5	2501	1876	1500	1250	1072	938	2084	1563	1250	1042	893	781	1667	1250	1000	834	714	625	1563	1172	938	781	670	586	1389	1042	834	695	595	521

LD 0 - Lopatka 0 długa
LD 1 - Lopatka 1 długa
LK 0 - Lopatka 0 krótka
LK 1 - Lopatka 1 krótka



Tabela wysiewu

SIPMA RN 610 ANTEK

Tarcza: 430

Lopatki I



NPK 4 - 10 - 22 Amofoska CORN

Gdańskie Zakłady Nawozów Fosforowych "Fosfory" Sp. z o.o.

Formuła nawozu: NPK 4-10-22
Klasa ziarnowa: frakcja 2-5,5 mm, nie mniej niż 90%
Gęstość nasypowa: 1,17 kg/dm³

Szerokość robocza	12 m						15 m						16 m						18 m					
Typ i ustawienie lopatek	LD I - 0,4						LD I - 0,4						LD I - 0,5						LD I - 1,2					
	LK I - 1,3						LK I - 1,4						LK I - 2						LK I - 2					
Obroty	540 obr/min						540 obr/min						540 obr/min						540 obr/min					
Dawka wysiewu	kg/ha																							
Nastawa	Prędk. robocza [km/h]						Prędk. robocza [km/h]						Prędk. robocza [km/h]						Prędk. robocza [km/h]					
	6	8	10	12	14	16	6	8	10	12	14	16	6	8	10	12	14	16	6	8	10	12	14	16
4	55	41	33	28	24	21	44	33	27	22	19	17	41	31	25	21	18	16	37	28	22	18	16	14
4,5	67	51	40	34	29	25	54	40	32	27	23	20	51	38	30	25	22	19	45	34	27	22	19	17
5	84	63	50	42	36	31	67	50	40	33	29	25	63	47	38	31	27	24	56	42	33	28	24	21
5,5	103	78	62	52	44	39	83	62	50	41	35	31	78	58	47	39	33	29	69	52	41	34	30	26
6	125	94	75	62	53	47	100	75	60	50	43	37	94	70	56	47	40	35	83	62	50	42	36	31
6,5	150	112	90	75	64	56	120	90	72	60	51	45	112	84	67	56	48	42	100	75	60	50	43	37
7	181	136	109	91	78	68	145	109	87	73	62	54	136	102	82	68	58	51	121	91	73	60	52	45
7,5	213	160	128	106	91	80	170	128	102	85	73	64	160	120	96	80	68	60	142	106	85	71	61	53
8	257	193	154	129	110	96	206	154	123	103	88	77	193	145	116	96	83	72	171	129	103	86	73	64
8,5	295	221	177	147	126	111	236	177	142	118	101	88	221	166	133	111	95	83	197	147	118	98	84	74
9	342	256	205	171	146	128	273	205	164	137	117	103	256	192	154	128	110	96	228	171	137	114	98	85
9,5	389	292	234	195	167	146	311	234	187	156	133	117	292	219	175	146	125	109	260	195	156	130	111	97
10	446	335	268	223	191	167	357	268	214	179	153	134	335	251	201	167	143	126	298	223	179	149	128	112
10,5	508	381	305	254	218	190	406	305	244	203	174	152	381	286	229	190	163	143	339	254	203	169	145	127
11	573	430	344	286	246	215	458	344	275	229	196	172	430	322	258	215	184	161	382	286	229	191	164	143
11,5	650	487	390	325	279	244	520	390	312	260	223	195	487	366	292	244	209	183	433	325	260	217	186	162
12	720	540	432	360	309	270	576	432	346	288	247	216	540	405	324	270	231	203	480	360	288	240	206	180
12,5	810	608	486	405	347	304	648	486	389	324	278	243	608	456	365	304	261	228	540	405	324	270	232	203
13	921	691	552	460	395	345	737	552	442	368	316	276	691	518	414	345	296	259	614	460	368	307	263	230
13,5	1006	755	604	503	431	377	805	604	483	403	345	302	755	566	453	377	323	283	671	503	403	335	288	252
14	1110	832	666	555	476	416	888	666	533	444	380	333	832	624	499	416	357	312	740	555	444	370	317	277
14,5	1214	911	729	607	520	455	971	729	583	486	416	364	911	683	546	455	390	341	809	607	486	405	347	304
15	1336	1002	801	668	572	501	1069	801	641	534	458	401	1002	751	601	501	429	376	890	668	534	445	382	334
15,5	1448	1086	869	724	621	543	1159	869	695	579	497	434	1086	815	652	543	465	407	965	724	579	483	414	362
16	1576	1182	946	788	676	591	1261	946	757	631	540	473	1182	887	709	591	507	443	1051	788	631	525	450	394
16,5	1751	1314	1051	876	751	657	1401	1051	841	701	600	525	1314	985	788	657	563	493	1168	876	701	584	500	438
17	1870	1403	1122	935	802	701	1496	1122	898	748	641	561	1403	1052	842	701	601	526	1247	935	748	623	534	468
17,5	1977	1482	1186	988	847	741	1581	1186	949	791	678	593	1482	1112	889	741	635	556	1318	988	791	659	565	494
18	2029	1522	1218	1015	870	761	1623	1218	974	812	696	609	1522	1142	913	761	652	571	1353	1015	812	676	580	507
18,5	2080	1560	1248	1040	891	780	1664	1248	998	832	713	624	1560	1170	936	780	668	585	1386	1040	832	693	594	520

LD 0 - Lopatka 0 długa
LD I - Lopatka I długa
LK 0 - Lopatka 0 krótka
LK I - Lopatka I krótka



Tabela wysiewu

SIPMA RN 610 ANTEK

Tarcza: 430

Lopatki I



NPK 4 - 10 - 22 Amofoska CORN

Gdańskie Zakłady Nawozów Fosforowych "Fosfory" Sp. z o.o.

Formuła nawozu: NPK 4-10-22
Klasa ziarnowa: frakcja 2-5,5 mm, nie mniej niż 90%
Gęstość nasypowa: 1,17 kg/dm³

Szerokość robocza	20 m						21 m						24 m					
Typ i ustawienie lopatek	LD I - 2,2						LD I - 2,5						LD I - 3					
	LK I - 1,4						LK I - 2						LK I - 2					
Obroty	540 obr/min						540 obr/min						540 obr/min					
Dawka wysiewu	kg/ha																	
Nastawa	Prędk. robocza [km/h]						Prędk. robocza [km/h]						Prędk. robocza [km/h]					
	6	8	10	12	14	16	6	8	10	12	14	16	6	8	10	12	14	16
4	33	25	20	17	14	12	32	24	19	16	14	12	28	21	17	14	12	10
4,5	40	30	24	20	17	15	39	29	23	19	17	14	34	25	20	17	14	13
5	50	38	30	25	22	19	48	36	29	24	20	18	42	31	25	21	18	16
5,5	62	47	37	31	27	23	59	44	35	30	25	22	52	39	31	26	22	19
6	75	56	45	37	32	28	71	53	43	36	31	27	62	47	37	31	27	23
6,5	90	67	54	45	39	34	86	64	51	43	37	32	75	56	45	37	32	28
7	109	82	65	54	47	41	104	78	62	52	44	39	91	68	54	45	39	34
7,5	128	96	77	64	55	48	122	91	73	61	52	46	106	80	64	53	46	40
8	154	116	93	77	66	58	147	110	88	73	63	55	129	96	77	64	55	48
8,5	177	133	106	88	76	66	168	126	101	84	72	63	147	111	88	74	63	55
9	205	154	123	103	88	77	195	146	117	98	84	73	171	128	103	85	73	64
9,5	234	175	140	117	100	88	222	167	133	111	95	83	195	146	117	97	83	73
10	268	201	161	134	115	100	255	191	153	128	109	96	223	167	134	112	96	84
10,5	305	229	183	152	131	114	290	218	174	145	124	109	254	190	152	127	109	95
11	344	258	206	172	147	129	327	246	196	164	140	123	286	215	172	143	123	107
11,5	390	292	234	195	167	146	371	279	223	186	159	139	325	244	195	162	139	122
12	432	324	259	216	185	162	411	309	247	206	176	154	360	270	216	180	154	135
12,5	486	365	292	243	208	182	463	347	278	232	198	174	405	304	243	203	174	152
13	552	414	331	276	237	207	526	395	316	263	225	197	460	345	276	230	197	173
13,5	604	453	362	302	259	226	575	431	345	288	246	216	503	377	302	252	216	189
14	666	499	399	333	285	250	634	476	380	317	272	238	555	416	333	277	238	208
14,5	729	546	437	364	312	273	694	520	416	347	297	260	607	455	364	304	260	228
15	801	601	481	401	343	301	763	572	458	382	327	286	668	501	401	334	286	250
15,5	869	652	521	434	372	326	828	621	497	414	355	310	724	543	434	362	310	272
16	946	709	567	473	405	355	901	676	540	450	386	338	788	591	473	394	338	296
16,5	1051	788	630	525	450	394	1001	751	600	500	429	375	876	657	525	438	375	328
17	1122	842	673	561	481	421	1069	802	641	534	458	401	935	701	561	468	401	351
17,5	1186	889	712	593	508	445	1129	847	678	565	484	424	988	741	593	494	424	371
18	1218	913	731	609	522	457	1160	870	696	580	497	435	1015	761	609	507	435	381
18,5	1248	936	749	624	535	468	1188	891	713	594	509	446	1040	780	624	520	446	390

LD 0 - Lopatka 0 długa
LD I - Lopatka I długa
LK 0 - Lopatka 0 krótka
LK I - Lopatka I krótka



Tabela wysiewu

SIPMA RN 610 ANTEK

Tarcza: 430

Lopatki 0



NPK 5 - 10 - 25 Amofoska

Gdańskie Zakłady Nawozów Fosforowych "Fosfory" Sp. z o.o.

Formuła nawozu: NPK 5-10-25 z borem
Klasa ziarnowa: frakcja 2-5,5 mm, nie mniej niż 90%
Gęstość nasypowa: 1,16 kg/dm³

Szerokość robocza	10 m						12 m						15 m						16 m						18 m					
Typ i ustawienie lopatek	LD 0 - 0,4						LD 0 - 2						LD 0 - 2,5						LD 0 - 3,2						LD 0 - 3,4					
	LK 0 - 1,4						LK 0 - 2						LK 0 - 2						LK 0 - 2,2						LK 0 - 2,2					
Obroty	540 obr/min						540 obr/min						540 obr/min						540 obr/min						540 obr/min					
Dawka wysiewu	kg/ha																													
Nastawa	Prędk. robocza [km/h]						Prędk. robocza [km/h]						Prędk. robocza [km/h]						Prędk. robocza [km/h]						Prędk. robocza [km/h]					
	6	8	10	12	14	16	6	8	10	12	14	16	6	8	10	12	14	16	6	8	10	12	14	16	6	8	10	12	14	16
4	66	50	40	33	28	25	55	41	33	28	24	21	44	33	27	22	19	17	41	31	25	21	18	16	37	28	22	18	16	14
4,5	81	61	49	40	35	30	67	51	40	34	29	25	54	40	32	27	23	20	51	38	30	25	22	19	45	34	27	22	19	17
5	100	75	60	50	43	38	84	63	50	42	36	31	67	50	40	33	29	25	63	47	38	31	27	24	56	42	33	28	24	21
5,5	124	93	74	62	53	47	103	78	62	52	44	39	83	62	50	41	35	31	78	58	47	39	33	29	69	52	41	34	30	26
6	150	112	90	75	64	56	125	94	75	62	53	47	100	75	60	50	43	37	94	70	56	47	40	35	83	62	50	42	36	31
6,5	180	135	108	90	77	67	150	112	90	75	64	56	120	90	72	60	51	45	112	84	67	56	48	42	100	75	60	50	43	37
7	218	163	131	109	93	82	181	136	109	91	78	68	145	109	87	73	62	54	136	102	82	68	58	51	121	91	73	60	52	45
7,5	255	192	153	128	109	96	213	160	128	106	91	80	170	128	102	85	73	64	160	120	96	80	68	60	142	106	85	71	61	53
8	309	232	185	154	132	116	257	193	154	129	110	96	206	154	123	103	88	77	193	145	116	96	83	72	171	129	103	86	73	64
8,5	354	265	212	177	152	133	295	221	177	147	126	111	236	177	142	118	101	88	221	166	133	111	95	83	197	147	118	98	84	74
9	410	308	246	205	176	154	342	256	205	171	146	128	273	205	164	137	117	103	256	192	154	128	110	96	228	171	137	114	98	85
9,5	467	350	280	234	200	175	389	292	234	195	167	146	311	234	187	156	133	117	292	219	175	146	125	109	260	195	156	130	111	97
10	536	402	321	268	230	201	446	335	268	223	191	167	357	268	214	179	153	134	335	251	201	167	143	126	298	223	179	149	128	112
10,5	609	457	366	305	261	229	508	381	305	254	218	190	406	305	244	203	174	152	381	286	229	190	163	143	339	254	203	169	145	127
11	687	516	412	344	295	258	573	430	344	286	246	215	458	344	275	229	196	172	430	322	258	215	184	161	382	286	229	191	164	143
11,5	780	585	468	390	334	292	650	487	390	325	279	244	520	390	312	260	223	195	487	366	292	244	209	183	433	325	260	217	186	162
12	864	648	518	432	370	324	720	540	432	360	309	270	576	432	346	288	247	216	540	405	324	270	231	203	480	360	288	240	206	180
12,5	973	729	584	486	417	365	810	608	486	405	347	304	648	486	389	324	278	243	608	456	365	304	261	228	540	405	324	270	232	203
13	1105	829	663	552	474	414	921	691	552	460	395	345	737	552	442	368	316	276	691	518	414	345	296	259	614	460	368	307	263	230
13,5	1208	906	725	604	518	453	1006	755	604	503	431	377	805	604	483	403	345	302	755	566	453	377	323	283	671	503	403	335	288	252
14	1332	999	799	666	571	499	1110	832	666	555	476	416	888	666	533	444	380	333	832	624	499	416	357	312	740	555	444	370	317	277
14,5	1457	1093	874	729	624	546	1214	911	729	607	520	455	971	729	583	486	416	364	911	683	546	455	390	341	809	607	486	405	347	304
15	1603	1202	962	801	687	601	1336	1002	801	668	572	501	1069	801	641	534	458	401	1002	751	601	501	429	376	890	668	534	445	382	334
15,5	1738	1303	1043	869	745	652	1448	1086	869	724	621	543	1159	869	695	579	497	434	1086	815	652	543	465	407	965	724	579	483	414	362
16	1892	1419	1135	946	811	709	1576	1182	946	788	676	591	1261	946	757	631	540	473	1182	887	709	591	507	443	1051	788	631	525	450	394
16,5	2102	1576	1261	1051	901	788	1751	1314	1051	876	751	657	1401	1051	841	701	600	525	1314	985	788	657	563	493	1168	876	701	584	500	438
17	2244	1683	1347	1122	962	842	1870	1403	1122	935	802	701	1496	1122	898	748	641	561	1403	1052	842	701	601	526	1247	935	748	623	534	468
17,5	2372	1779	1423	1186	1016	889	1977	1482	1186	988	847	741	1581	1186	949	791	678	593	1482	1112	889	741	635	556	1318	988	791	659	565	494
18	2435	1826	1461	1218	1044	913	2029	1522	1218	1015	870	761	1623	1218	974	812	696	609	1522	1142	913	761	652	571	1353	1015	812	676	580	507
18,5	2501	1876	1500	1250	1072	938	2084	1563	1250	1042	893	781	1667	1250	1000	834	714	625	1563	1172	938	781	670	586	1389	1042	834	695	595	521

LD 0 - Lopatka 0 długa
LD 1 - Lopatka I długa
LK 0 - Lopatka 0 krótka
LK 1 - Lopatka I krótka



Tabela wysiewu

SIPMA RN 610 ANTEK

Tarcza: 430

Lopatki I

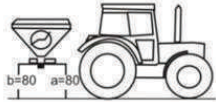

NPK 5 - 10 - 25 Amofoska

Gdańskie Zakłady Nawozów Fosforowych "Fosfory" Sp. z o.o.

Formuła nawozu: NPK 5-10-25 z borem
Klasa ziarnowa: frakcja 2-5,5 mm, nie mniej niż 90%
Gęstość nasypowa: 1,16 kg/dm³

Szerokość robocza	12 m						15 m						16 m						18 m					
Typ i ustawienie lopatek	LD I - 0,4						LD I - 0,4						LD I - 0,5						LD I - 1,2					
	LK I - 1,3						LK I - 1,4						LK I - 2						LK I - 2					
Obroty	540 obr/min						540 obr/min						540 obr/min						540 obr/min					
Dawka wysiewu	kg/ha																							
Nastawa	Prędk. robocza [km/h]						Prędk. robocza [km/h]						Prędk. robocza [km/h]						Prędk. robocza [km/h]					
	6	8	10	12	14	16	6	8	10	12	14	16	6	8	10	12	14	16	6	8	10	12	14	16
4	55	41	33	28	24	21	44	33	27	22	19	17	41	31	25	21	18	16	37	28	22	18	16	14
4,5	67	51	40	34	29	25	54	40	32	27	23	20	51	38	30	25	22	19	45	34	27	22	19	17
5	84	63	50	42	36	31	67	50	40	33	29	25	63	47	38	31	27	24	56	42	33	28	24	21
5,5	103	78	62	52	44	39	83	62	50	41	35	31	78	58	47	39	33	29	69	52	41	34	30	26
6	125	94	75	62	53	47	100	75	60	50	43	37	94	70	56	47	40	35	83	62	50	42	36	31
6,5	150	112	90	75	64	56	120	90	72	60	51	45	112	84	67	56	48	42	100	75	60	50	43	37
7	181	136	109	91	78	68	145	109	87	73	62	54	136	102	82	68	58	51	121	91	73	60	52	45
7,5	213	160	128	106	91	80	170	128	102	85	73	64	160	120	96	80	68	60	142	106	85	71	61	53
8	257	193	154	129	110	96	206	154	123	103	88	77	193	145	116	96	83	72	171	129	103	86	73	64
8,5	295	221	177	147	126	111	236	177	142	118	101	88	221	166	133	111	95	83	197	147	118	98	84	74
9	342	256	205	171	146	128	273	205	164	137	117	103	256	192	154	128	110	96	228	171	137	114	98	85
9,5	389	292	234	195	167	146	311	234	187	156	133	117	292	219	175	146	125	109	260	195	156	130	111	97
10	446	335	268	223	191	167	357	268	214	179	153	134	335	251	201	167	143	126	298	223	179	149	128	112
10,5	508	381	305	254	218	190	406	305	244	203	174	152	381	286	229	190	163	143	339	254	203	169	145	127
11	573	430	344	286	246	215	458	344	275	229	196	172	430	322	258	215	184	161	382	286	229	191	164	143
11,5	650	487	390	325	279	244	520	390	312	260	223	195	487	366	292	244	209	183	433	325	260	217	186	162
12	720	540	432	360	309	270	576	432	346	288	247	216	540	405	324	270	231	203	480	360	288	240	206	180
12,5	810	608	486	405	347	304	648	486	389	324	278	243	608	456	365	304	261	228	540	405	324	270	232	203
13	921	691	552	460	395	345	737	552	442	368	316	276	691	518	414	345	296	259	614	460	368	307	263	230
13,5	1006	755	604	503	431	377	805	604	483	403	345	302	755	566	453	377	323	283	671	503	403	335	288	252
14	1110	832	666	555	476	416	888	666	533	444	380	333	832	624	499	416	357	312	740	555	444	370	317	277
14,5	1214	911	729	607	520	455	971	729	583	486	416	364	911	683	546	455	390	341	809	607	486	405	347	304
15	1336	1002	801	668	572	501	1069	801	641	534	458	401	1002	751	601	501	429	376	890	668	534	445	382	334
15,5	1448	1086	869	724	621	543	1159	869	695	579	497	434	1086	815	652	543	465	407	965	724	579	483	414	362
16	1576	1182	946	788	676	591	1261	946	757	631	540	473	1182	887	709	591	507	443	1051	788	631	525	450	394
16,5	1751	1314	1051	876	751	657	1401	1051	841	701	600	525	1314	985	788	657	563	493	1168	876	701	584	500	438
17	1870	1403	1122	935	802	701	1496	1122	898	748	641	561	1403	1052	842	701	601	526	1247	935	748	623	534	468
17,5	1977	1482	1186	988	847	741	1581	1186	949	791	678	593	1482	1112	889	741	635	556	1318	988	791	659	565	494
18	2029	1522	1218	1015	870	761	1623	1218	974	812	696	609	1522	1142	913	761	652	571	1353	1015	812	676	580	507
18,5	2080	1560	1248	1040	891	780	1664	1248	998	832	713	624	1560	1170	936	780	668	585	1386	1040	832	693	594	520

LD 0 - Lopatka 0 długa
LD I - Lopatka I długa
LK 0 - Lopatka 0 krótka
LK I - Lopatka I krótka



Tabela wysiewu

SIPMA RN 610 ANTEK

Tarcza: 430

Lopatki I



NPK 5 - 10 - 25 Amofoska

Gdańskie Zakłady Nawozów Fosforowych "Fosfory" Sp. z o.o.

Formuła nawozu: NPK 5-10-25 z borem
Klasa ziarnowa: frakcja 2-5,5 mm, nie mniej niż 90%
Gęstość nasypowa: 1,16 kg/dm³

Szerokość robocza	20 m						21 m						24 m					
Typ i ustawienie lopatek	LD I - 2,2						LD I - 2,5						LD I - 3					
	LK I - 1,4						LK I - 2						LK I - 2					
Obroty	540 obr/min						540 obr/min						540 obr/min					
Dawka wysiewu	kg/ha																	
Nastawa	Prędk. robocza [km/h]						Prędk. robocza [km/h]						Prędk. robocza [km/h]					
	6	8	10	12	14	16	6	8	10	12	14	16	6	8	10	12	14	16
4	33	25	20	17	14	12	32	24	19	16	14	12	28	21	17	14	12	10
4,5	40	30	24	20	17	15	39	29	23	19	17	14	34	25	20	17	14	13
5	50	38	30	25	22	19	48	36	29	24	20	18	42	31	25	21	18	16
5,5	62	47	37	31	27	23	59	44	35	30	25	22	52	39	31	26	22	19
6	75	56	45	37	32	28	71	53	43	36	31	27	62	47	37	31	27	23
6,5	90	67	54	45	39	34	86	64	51	43	37	32	75	56	45	37	32	28
7	109	82	65	54	47	41	104	78	62	52	44	39	91	68	54	45	39	34
7,5	128	96	77	64	55	48	122	91	73	61	52	46	106	80	64	53	46	40
8	154	116	93	77	66	58	147	110	88	73	63	55	129	96	77	64	55	48
8,5	177	133	106	88	76	66	168	126	101	84	72	63	147	111	88	74	63	55
9	205	154	123	103	88	77	195	146	117	98	84	73	171	128	103	85	73	64
9,5	234	175	140	117	100	88	222	167	133	111	95	83	195	146	117	97	83	73
10	268	201	161	134	115	100	255	191	153	128	109	96	223	167	134	112	96	84
10,5	305	229	183	152	131	114	290	218	174	145	124	109	254	190	152	127	109	95
11	344	258	206	172	147	129	327	246	196	164	140	123	286	215	172	143	123	107
11,5	390	292	234	195	167	146	371	279	223	186	159	139	325	244	195	162	139	122
12	432	324	259	216	185	162	411	309	247	206	176	154	360	270	216	180	154	135
12,5	486	365	292	243	208	182	463	347	278	232	198	174	405	304	243	203	174	152
13	552	414	331	276	237	207	526	395	316	263	225	197	460	345	276	230	197	173
13,5	604	453	362	302	259	226	575	431	345	288	246	216	503	377	302	252	216	189
14	666	499	399	333	285	250	634	476	380	317	272	238	555	416	333	277	238	208
14,5	729	546	437	364	312	273	694	520	416	347	297	260	607	455	364	304	260	228
15	801	601	481	401	343	301	763	572	458	382	327	286	668	501	401	334	286	250
15,5	869	652	521	434	372	326	828	621	497	414	355	310	724	543	434	362	310	272
16	946	709	567	473	405	355	901	676	540	450	386	338	788	591	473	394	338	296
16,5	1051	788	630	525	450	394	1001	751	600	500	429	375	876	657	525	438	375	328
17	1122	842	673	561	481	421	1069	802	641	534	458	401	935	701	561	468	401	351
17,5	1186	889	712	593	508	445	1129	847	678	565	484	424	988	741	593	494	424	371
18	1218	913	731	609	522	457	1160	870	696	580	497	435	1015	761	609	507	435	381
18,5	1248	936	749	624	535	468	1188	891	713	594	509	446	1040	780	624	520	446	390

LD 0 - Lopatka 0 długa
LD I - Lopatka I długa
LK 0 - Lopatka 0 krótka
LK I - Lopatka I krótka



Tabela wysiewu

SIPMA RN 610 ANTEK

Tarcza: 430

Lopatki 0



NPK 4 - 12 - 12 Amofoska

Gdańskie Zakłady Nawozów Fosforowych "Fosfory" Sp. z o.o.

Formuła nawozu: NPK 4-12-12
Klasa ziarnowa: frakcja 2-5,5mm, nie mniej niż 90%
Gęstość nasypowa: 1,19 kg/dm³

Szerokość robocza	10 m						15 m						16 m						18 m						20 m					
Typ i ustawienie lopatek	LD 0 - 0,4						LD 0 - 2						LD 0 - 2,5						LD 0 - 3,2						LD 0 - 3,4					
	LK 0 - 1,4						LK 0 - 2						LK 0 - 2						LK 0 - 2,2						LK 0 - 2,2					
Obroty	540 obr/min						540 obr/min						540 obr/min						540 obr/min						540 obr/min					
Dawka wysiewu	kg/ha																													
Nastawa	Prędk. robocza [km/h]						Prędk. robocza [km/h]						Prędk. robocza [km/h]						Prędk. robocza [km/h]						Prędk. robocza [km/h]					
	6	8	10	12	14	16	6	8	10	12	14	16	6	8	10	12	14	16	6	8	10	12	14	16	6	8	10	12	14	16
4	66	50	40	33	28	25	44	33	27	22	19	17	41	31	25	21	18	16	37	28	22	18	16	14	33	25	20	17	14	12
4,5	81	61	49	40	35	30	54	40	32	27	23	20	51	38	30	25	22	19	45	34	27	22	19	17	40	30	24	20	17	15
5	100	75	60	50	43	38	67	50	40	33	29	25	63	47	38	31	27	24	56	42	33	28	24	21	50	38	30	25	22	19
5,5	124	93	74	62	53	47	83	62	50	41	35	31	78	58	47	39	33	29	69	52	41	34	30	26	62	47	37	31	27	23
6	150	112	90	75	64	56	100	75	60	50	43	37	94	70	56	47	40	35	83	62	50	42	36	31	75	56	45	37	32	28
6,5	180	135	108	90	77	67	120	90	72	60	51	45	112	84	67	56	48	42	100	75	60	50	43	37	90	67	54	45	39	34
7	218	163	131	109	93	82	145	109	87	73	62	54	136	102	82	68	58	51	121	91	73	60	52	45	109	82	65	54	47	41
7,5	255	192	153	128	109	96	170	128	102	85	73	64	160	120	96	80	68	60	142	106	85	71	61	53	128	96	77	64	55	48
8	309	232	185	154	132	116	206	154	123	103	88	77	193	145	116	96	83	72	171	129	103	86	73	64	154	116	93	77	66	58
8,5	354	265	212	177	152	133	236	177	142	118	101	88	221	166	133	111	95	83	197	147	118	98	84	74	177	133	106	88	76	66
9	410	308	246	205	176	154	273	205	164	137	117	103	256	192	154	128	110	96	228	171	137	114	98	85	205	154	123	103	88	77
9,5	467	350	280	234	200	175	311	234	187	156	133	117	292	219	175	146	125	109	260	195	156	130	111	97	234	175	140	117	100	88
10	536	402	321	268	230	201	357	268	214	179	153	134	335	251	201	167	143	126	298	223	179	149	128	112	268	201	161	134	115	100
10,5	609	457	366	305	261	229	406	305	244	203	174	152	381	286	229	190	163	143	339	254	203	169	145	127	305	229	183	152	131	114
11	687	516	412	344	295	258	458	344	275	229	196	172	430	322	258	215	184	161	382	286	229	191	164	143	344	258	206	172	147	129
11,5	780	585	468	390	334	292	520	390	312	260	223	195	487	366	292	244	209	183	433	325	260	217	186	162	390	292	234	195	167	146
12	864	648	518	432	370	324	576	432	346	288	247	216	540	405	324	270	231	203	480	360	288	240	206	180	432	324	259	216	185	162
12,5	973	729	584	486	417	365	648	486	389	324	278	243	608	456	365	304	261	228	540	405	324	270	232	203	486	365	292	243	208	182
13	1105	829	663	552	474	414	737	552	442	368	316	276	691	518	414	345	296	259	614	460	368	307	263	230	552	414	331	276	237	207
13,5	1208	906	725	604	518	453	805	604	483	403	345	302	755	566	453	377	323	283	671	503	403	335	288	252	604	453	362	302	259	226
14	1332	999	799	666	571	499	888	666	533	444	380	333	832	624	499	416	357	312	740	555	444	370	317	277	666	499	399	333	285	250
14,5	1457	1093	874	729	624	546	971	729	583	486	416	364	911	683	546	455	390	341	809	607	486	405	347	304	729	546	437	364	312	273
15	1603	1202	962	801	687	601	1069	801	641	534	458	401	1002	751	601	501	429	376	890	668	534	445	382	334	801	601	481	401	343	301
15,5	1738	1303	1043	869	745	652	1159	869	695	579	497	434	1086	815	652	543	465	407	965	724	579	483	414	362	869	652	521	434	372	326
16	1892	1419	1135	946	811	709	1261	946	757	631	540	473	1182	887	709	591	507	443	1051	788	631	525	450	394	946	709	567	473	405	355
16,5	2102	1576	1261	1051	901	788	1401	1051	841	701	600	525	1314	985	788	657	563	493	1168	876	701	584	500	438	1051	788	630	525	450	394
17	2244	1683	1347	1122	962	842	1496	1122	898	748	641	561	1403	1052	842	701	601	526	1247	935	748	623	534	468	1122	842	673	561	481	421
17,5	2372	1779	1423	1186	1016	889	1581	1186	949	791	678	593	1482	1112	889	741	635	556	1318	988	791	659	565	494	1186	889	712	593	508	445
18	2435	1826	1461	1218	1044	913	1623	1218	974	812	696	609	1522	1142	913	761	652	571	1353	1015	812	676	580	507	1218	913	731	609	522	457
18,5	2501	1876	1500	1250	1072	938	1667	1250	1000	834	714	625	1563	1172	938	781	670	586	1389	1042	834	695	595	521	1250	938	750	625	536	469

LD 0 - Lopatka 0 długa
LD 1 - Lopatka I długa
LK 0 - Lopatka 0 krótka
LK 1 - Lopatka I krótka



Tabela wysiewu

SIPMA RN 610 ANTEK

Tarcza: 430

Lopatki I



NPK 4 - 12 - 12 Amofoska

Gdańskie Zakłady Nawozów Fosforowych "Fosfory" Sp. z o.o.

Formuła nawozu: NPK 4-12-12
Klasa ziarnowa: frakcja 2-5,5mm, nie mniej niż 90%
Gęstość nasypowa: 1,19 kg/dm³

Szerokość robocza	12 m						15 m						16 m						18 m					
Typ i ustawienie lopatek	LD I - 0,4						LD I - 0,4						LD I - 0,5						LD I - 1,2					
	LK I - 1,3						LK I - 1,4						LK I - 2						LK I - 2					
Obroty	540 obr/min						540 obr/min						540 obr/min						540 obr/min					
Dawka wysiewu	kg/ha																							
Nastawa	Prędk. robocza [km/h]						Prędk. robocza [km/h]						Prędk. robocza [km/h]						Prędk. robocza [km/h]					
	6	8	10	12	14	16	6	8	10	12	14	16	6	8	10	12	14	16	6	8	10	12	14	16
4	55	41	33	28	24	21	44	33	27	22	19	17	41	31	25	21	18	16	37	28	22	18	16	14
4,5	67	51	40	34	29	25	54	40	32	27	23	20	51	38	30	25	22	19	45	34	27	22	19	17
5	84	63	50	42	36	31	67	50	40	33	29	25	63	47	38	31	27	24	56	42	33	28	24	21
5,5	103	78	62	52	44	39	83	62	50	41	35	31	78	58	47	39	33	29	69	52	41	34	30	26
6	125	94	75	62	53	47	100	75	60	50	43	37	94	70	56	47	40	35	83	62	50	42	36	31
6,5	150	112	90	75	64	56	120	90	72	60	51	45	112	84	67	56	48	42	100	75	60	50	43	37
7	181	136	109	91	78	68	145	109	87	73	62	54	136	102	82	68	58	51	121	91	73	60	52	45
7,5	213	160	128	106	91	80	170	128	102	85	73	64	160	120	96	80	68	60	142	106	85	71	61	53
8	257	193	154	129	110	96	206	154	123	103	88	77	193	145	116	96	83	72	171	129	103	86	73	64
8,5	295	221	177	147	126	111	236	177	142	118	101	88	221	166	133	111	95	83	197	147	118	98	84	74
9	342	256	205	171	146	128	273	205	164	137	117	103	256	192	154	128	110	96	228	171	137	114	98	85
9,5	389	292	234	195	167	146	311	234	187	156	133	117	292	219	175	146	125	109	260	195	156	130	111	97
10	446	335	268	223	191	167	357	268	214	179	153	134	335	251	201	167	143	126	298	223	179	149	128	112
10,5	508	381	305	254	218	190	406	305	244	203	174	152	381	286	229	190	163	143	339	254	203	169	145	127
11	573	430	344	286	246	215	458	344	275	229	196	172	430	322	258	215	184	161	382	286	229	191	164	143
11,5	650	487	390	325	279	244	520	390	312	260	223	195	487	366	292	244	209	183	433	325	260	217	186	162
12	720	540	432	360	309	270	576	432	346	288	247	216	540	405	324	270	231	203	480	360	288	240	206	180
12,5	810	608	486	405	347	304	648	486	389	324	278	243	608	456	365	304	261	228	540	405	324	270	232	203
13	921	691	552	460	395	345	737	552	442	368	316	276	691	518	414	345	296	259	614	460	368	307	263	230
13,5	1006	755	604	503	431	377	805	604	483	403	345	302	755	566	453	377	323	283	671	503	403	335	288	252
14	1110	832	666	555	476	416	888	666	533	444	380	333	832	624	499	416	357	312	740	555	444	370	317	277
14,5	1214	911	729	607	520	455	971	729	583	486	416	364	911	683	546	455	390	341	809	607	486	405	347	304
15	1336	1002	801	668	572	501	1069	801	641	534	458	401	1002	751	601	501	429	376	890	668	534	445	382	334
15,5	1448	1086	869	724	621	543	1159	869	695	579	497	434	1086	815	652	543	465	407	965	724	579	483	414	362
16	1576	1182	946	788	676	591	1261	946	757	631	540	473	1182	887	709	591	507	443	1051	788	631	525	450	394
16,5	1751	1314	1051	876	751	657	1401	1051	841	701	600	525	1314	985	788	657	563	493	1168	876	701	584	500	438
17	1870	1403	1122	935	802	701	1496	1122	898	748	641	561	1403	1052	842	701	601	526	1247	935	748	623	534	468
17,5	1977	1482	1186	988	847	741	1581	1186	949	791	678	593	1482	1112	889	741	635	556	1318	988	791	659	565	494
18	2029	1522	1218	1015	870	761	1623	1218	974	812	696	609	1522	1142	913	761	652	571	1353	1015	812	676	580	507
18,5	2080	1560	1248	1040	891	780	1664	1248	998	832	713	624	1560	1170	936	780	668	585	1386	1040	832	693	594	520

LD 0 - Lopatka 0 długa
LD I - Lopatka I długa
LK 0 - Lopatka 0 krótka
LK I - Lopatka I krótka



Tabela wysiewu

SIPMA RN 610 ANTEK

Tarcza: 430

Lopatki I



NPK 4 - 12 - 12 Amofoska

Gdańskie Zakłady Nawozów Fosforowych "Fosfory" Sp. z o.o.

Formuła nawozu: NPK 4-12-12
Klasa ziarnowa: frakcja 2-5,5mm, nie mniej niż 90%
Gęstość nasypowa: 1,19 kg/dm³

Szerokość robocza	20 m						21 m						24 m					
Typ i ustawienie lopatek	LD I - 2,2						LD I - 2,5						LD I - 3					
	LK I - 1,4						LK I - 2						LK I - 2					
Obroty	540 obr/min						540 obr/min						540 obr/min					
Dawka wysiewu	kg/ha																	
Nastawa	Prędk. robocza [km/h]						Prędk. robocza [km/h]						Prędk. robocza [km/h]					
	6	8	10	12	14	16	6	8	10	12	14	16	6	8	10	12	14	16
4	33	25	20	17	14	12	32	24	19	16	14	12	28	21	17	14	12	10
4,5	40	30	24	20	17	15	39	29	23	19	17	14	34	25	20	17	14	13
5	50	38	30	25	22	19	48	36	29	24	20	18	42	31	25	21	18	16
5,5	62	47	37	31	27	23	59	44	35	30	25	22	52	39	31	26	22	19
6	75	56	45	37	32	28	71	53	43	36	31	27	62	47	37	31	27	23
6,5	90	67	54	45	39	34	86	64	51	43	37	32	75	56	45	37	32	28
7	109	82	65	54	47	41	104	78	62	52	44	39	91	68	54	45	39	34
7,5	128	96	77	64	55	48	122	91	73	61	52	46	106	80	64	53	46	40
8	154	116	93	77	66	58	147	110	88	73	63	55	129	96	77	64	55	48
8,5	177	133	106	88	76	66	168	126	101	84	72	63	147	111	88	74	63	55
9	205	154	123	103	88	77	195	146	117	98	84	73	171	128	103	85	73	64
9,5	234	175	140	117	100	88	222	167	133	111	95	83	195	146	117	97	83	73
10	268	201	161	134	115	100	255	191	153	128	109	96	223	167	134	112	96	84
10,5	305	229	183	152	131	114	290	218	174	145	124	109	254	190	152	127	109	95
11	344	258	206	172	147	129	327	246	196	164	140	123	286	215	172	143	123	107
11,5	390	292	234	195	167	146	371	279	223	186	159	139	325	244	195	162	139	122
12	432	324	259	216	185	162	411	309	247	206	176	154	360	270	216	180	154	135
12,5	486	365	292	243	208	182	463	347	278	232	198	174	405	304	243	203	174	152
13	552	414	331	276	237	207	526	395	316	263	225	197	460	345	276	230	197	173
13,5	604	453	362	302	259	226	575	431	345	288	246	216	503	377	302	252	216	189
14	666	499	399	333	285	250	634	476	380	317	272	238	555	416	333	277	238	208
14,5	729	546	437	364	312	273	694	520	416	347	297	260	607	455	364	304	260	228
15	801	601	481	401	343	301	763	572	458	382	327	286	668	501	401	334	286	250
15,5	869	652	521	434	372	326	828	621	497	414	355	310	724	543	434	362	310	272
16	946	709	567	473	405	355	901	676	540	450	386	338	788	591	473	394	338	296
16,5	1051	788	630	525	450	394	1001	751	600	500	429	375	876	657	525	438	375	328
17	1122	842	673	561	481	421	1069	802	641	534	458	401	935	701	561	468	401	351
17,5	1186	889	712	593	508	445	1129	847	678	565	484	424	988	741	593	494	424	371
18	1218	913	731	609	522	457	1160	870	696	580	497	435	1015	761	609	507	435	381
18,5	1248	936	749	624	535	468	1188	891	713	594	509	446	1040	780	624	520	446	390

LD 0 - Lopatka 0 długa
LD I - Lopatka I długa
LK 0 - Lopatka 0 krótka
LK I - Lopatka I krótka



Tabela wysiewu

SIPMA RN 610 ANTEK

Tarcza: 430

Lopatkę 0

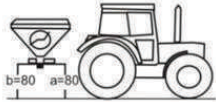

NPK 4 - 12 - 20 Amofoska

Gdańskie Zakłady Nawozów Fosforowych "Fosfory" Sp. z o.o.

Formuła nawozu: NPK 4-12-20
Klasa ziarnowa: frakcja 2-5,5mm, nie mniej niż 90%
Gęstość nasypowa: 1,19 kg/dm³

Szerokość robocza	10 m						12 m						15 m						16 m						18 m					
Typ i ustawienie lopatek	LD 0 - 0,4						LD 0 - 2						LD 0 - 2,5						LD 0 - 3,2						LD 0 - 3,4					
	LK 0 - 1,4						LK 0 - 2						LK 0 - 2						LK 0 - 2,2						LK 0 - 2,2					
Obroty	540 obr/min						540 obr/min						540 obr/min						540 obr/min						540 obr/min					
Dawka wysiewu	kg/ha																													
Nastawa	Prędk. robocza [km/h]						Prędk. robocza [km/h]						Prędk. robocza [km/h]						Prędk. robocza [km/h]						Prędk. robocza [km/h]					
	6	8	10	12	14	16	6	8	10	12	14	16	6	8	10	12	14	16	6	8	10	12	14	16	6	8	10	12	14	16
4	66	50	40	33	28	25	55	41	33	28	24	21	44	33	27	22	19	17	41	31	25	21	18	16	37	28	22	18	16	14
4,5	81	61	49	40	35	30	67	51	40	34	29	25	54	40	32	27	23	20	51	38	30	25	22	19	45	34	27	22	19	17
5	100	75	60	50	43	38	84	63	50	42	36	31	67	50	40	33	29	25	63	47	38	31	27	24	56	42	33	28	24	21
5,5	124	93	74	62	53	47	103	78	62	52	44	39	83	62	50	41	35	31	78	58	47	39	33	29	69	52	41	34	30	26
6	150	112	90	75	64	56	125	94	75	62	53	47	100	75	60	50	43	37	94	70	56	47	40	35	83	62	50	42	36	31
6,5	180	135	108	90	77	67	150	112	90	75	64	56	120	90	72	60	51	45	112	84	67	56	48	42	100	75	60	50	43	37
7	218	163	131	109	93	82	181	136	109	91	78	68	145	109	87	73	62	54	136	102	82	68	58	51	121	91	73	60	52	45
7,5	255	192	153	128	109	96	213	160	128	106	91	80	170	128	102	85	73	64	160	120	96	80	68	60	142	106	85	71	61	53
8	309	232	185	154	132	116	257	193	154	129	110	96	206	154	123	103	88	77	193	145	116	96	83	72	171	129	103	86	73	64
8,5	354	265	212	177	152	133	295	221	177	147	126	111	236	177	142	118	101	88	221	166	133	111	95	83	197	147	118	98	84	74
9	410	308	246	205	176	154	342	256	205	171	146	128	273	205	164	137	117	103	256	192	154	128	110	96	228	171	137	114	98	85
9,5	467	350	280	234	200	175	389	292	234	195	167	146	311	234	187	156	133	117	292	219	175	146	125	109	260	195	156	130	111	97
10	536	402	321	268	230	201	446	335	268	223	191	167	357	268	214	179	153	134	335	251	201	167	143	126	298	223	179	149	128	112
10,5	609	457	366	305	261	229	508	381	305	254	218	190	406	305	244	203	174	152	381	286	229	190	163	143	339	254	203	169	145	127
11	687	516	412	344	295	258	573	430	344	286	246	215	458	344	275	229	196	172	430	322	258	215	184	161	382	286	229	191	164	143
11,5	780	585	468	390	334	292	650	487	390	325	279	244	520	390	312	260	223	195	487	366	292	244	209	183	433	325	260	217	186	162
12	864	648	518	432	370	324	720	540	432	360	309	270	576	432	346	288	247	216	540	405	324	270	231	203	480	360	288	240	206	180
12,5	973	729	584	486	417	365	810	608	486	405	347	304	648	486	389	324	278	243	608	456	365	304	261	228	540	405	324	270	232	203
13	1105	829	663	552	474	414	921	691	552	460	395	345	737	552	442	368	316	276	691	518	414	345	296	259	614	460	368	307	263	230
13,5	1208	906	725	604	518	453	1006	755	604	503	431	377	805	604	483	403	345	302	755	566	453	377	323	283	671	503	403	335	288	252
14	1332	999	799	666	571	499	1110	832	666	555	476	416	888	666	533	444	380	333	832	624	499	416	357	312	740	555	444	370	317	277
14,5	1457	1093	874	729	624	546	1214	911	729	607	520	455	971	729	583	486	416	364	911	683	546	455	390	341	809	607	486	405	347	304
15	1603	1202	962	801	687	601	1336	1002	801	668	572	501	1069	801	641	534	458	401	1002	751	601	501	429	376	890	668	534	445	382	334
15,5	1738	1303	1043	869	745	652	1448	1086	869	724	621	543	1159	869	695	579	497	434	1086	815	652	543	465	407	965	724	579	483	414	362
16	1892	1419	1135	946	811	709	1576	1182	946	788	676	591	1261	946	757	631	540	473	1182	887	709	591	507	443	1051	788	631	525	450	394
16,5	2102	1576	1261	1051	901	788	1751	1314	1051	876	751	657	1401	1051	841	701	600	525	1314	985	788	657	563	493	1168	876	701	584	500	438
17	2244	1683	1347	1122	962	842	1870	1403	1122	935	802	701	1496	1122	898	748	641	561	1403	1052	842	701	601	526	1247	935	748	623	534	468
17,5	2372	1779	1423	1186	1016	889	1977	1482	1186	988	847	741	1581	1186	949	791	678	593	1482	1112	889	741	635	556	1318	988	791	659	565	494
18	2435	1826	1461	1218	1044	913	2029	1522	1218	1015	870	761	1623	1218	974	812	696	609	1522	1142	913	761	652	571	1353	1015	812	676	580	507
18,5	2501	1876	1500	1250	1072	938	2084	1563	1250	1042	893	781	1667	1250	1000	834	714	625	1563	1172	938	781	670	586	1389	1042	834	695	595	521

LD 0 - Lopatka 0 długa
LD 1 - Lopatka 1 długa
LK 0 - Lopatka 0 krótka
LK 1 - Lopatka 1 krótka



Tabela wysiewu

SIPMA RN 610 ANTEK

Tarcza: 430

Lopatki I



NPK 4 - 12 - 20 Amofoska

Gdańskie Zakłady Nawozów Fosforowych "Fosfory" Sp. z o.o.

Formuła nawozu: NPK 4-12-20
Klasa ziarnowa: frakcja 2-5,5 mm, nie mniej niż 90%
Gęstość nasypowa: 1,19 kg/dm³

Szerokość robocza	12 m						15 m						16 m						18 m					
Typ i ustawienie lopatek	LD I - 0,4						LD I - 0,4						LD I - 0,5						LD I - 1,2					
	LK I - 1,3						LK I - 1,4						LK I - 2						LK I - 2					
Obroty	540 obr/min						540 obr/min						540 obr/min						540 obr/min					
Dawka wysiewu	kg/ha																							
Nastawa	Prędk. robocza [km/h]						Prędk. robocza [km/h]						Prędk. robocza [km/h]						Prędk. robocza [km/h]					
	6	8	10	12	14	16	6	8	10	12	14	16	6	8	10	12	14	16	6	8	10	12	14	16
4	55	41	33	28	24	21	44	33	27	22	19	17	41	31	25	21	18	16	37	28	22	18	16	14
4,5	67	51	40	34	29	25	54	40	32	27	23	20	51	38	30	25	22	19	45	34	27	22	19	17
5	84	63	50	42	36	31	67	50	40	33	29	25	63	47	38	31	27	24	56	42	33	28	24	21
5,5	103	78	62	52	44	39	83	62	50	41	35	31	78	58	47	39	33	29	69	52	41	34	30	26
6	125	94	75	62	53	47	100	75	60	50	43	37	94	70	56	47	40	35	83	62	50	42	36	31
6,5	150	112	90	75	64	56	120	90	72	60	51	45	112	84	67	56	48	42	100	75	60	50	43	37
7	181	136	109	91	78	68	145	109	87	73	62	54	136	102	82	68	58	51	121	91	73	60	52	45
7,5	213	160	128	106	91	80	170	128	102	85	73	64	160	120	96	80	68	60	142	106	85	71	61	53
8	257	193	154	129	110	96	206	154	123	103	88	77	193	145	116	96	83	72	171	129	103	86	73	64
8,5	295	221	177	147	126	111	236	177	142	118	101	88	221	166	133	111	95	83	197	147	118	98	84	74
9	342	256	205	171	146	128	273	205	164	137	117	103	256	192	154	128	110	96	228	171	137	114	98	85
9,5	389	292	234	195	167	146	311	234	187	156	133	117	292	219	175	146	125	109	260	195	156	130	111	97
10	446	335	268	223	191	167	357	268	214	179	153	134	335	251	201	167	143	126	298	223	179	149	128	112
10,5	508	381	305	254	218	190	406	305	244	203	174	152	381	286	229	190	163	143	339	254	203	169	145	127
11	573	430	344	286	246	215	458	344	275	229	196	172	430	322	258	215	184	161	382	286	229	191	164	143
11,5	650	487	390	325	279	244	520	390	312	260	223	195	487	366	292	244	209	183	433	325	260	217	186	162
12	720	540	432	360	309	270	576	432	346	288	247	216	540	405	324	270	231	203	480	360	288	240	206	180
12,5	810	608	486	405	347	304	648	486	389	324	278	243	608	456	365	304	261	228	540	405	324	270	232	203
13	921	691	552	460	395	345	737	552	442	368	316	276	691	518	414	345	296	259	614	460	368	307	263	230
13,5	1006	755	604	503	431	377	805	604	483	403	345	302	755	566	453	377	323	283	671	503	403	335	288	252
14	1110	832	666	555	476	416	888	666	533	444	380	333	832	624	499	416	357	312	740	555	444	370	317	277
14,5	1214	911	729	607	520	455	971	729	583	486	416	364	911	683	546	455	390	341	809	607	486	405	347	304
15	1336	1002	801	668	572	501	1069	801	641	534	458	401	1002	751	601	501	429	376	890	668	534	445	382	334
15,5	1448	1086	869	724	621	543	1159	869	695	579	497	434	1086	815	652	543	465	407	965	724	579	483	414	362
16	1576	1182	946	788	676	591	1261	946	757	631	540	473	1182	887	709	591	507	443	1051	788	631	525	450	394
16,5	1751	1314	1051	876	751	657	1401	1051	841	701	600	525	1314	985	788	657	563	493	1168	876	701	584	500	438
17	1870	1403	1122	935	802	701	1496	1122	898	748	641	561	1403	1052	842	701	601	526	1247	935	748	623	534	468
17,5	1977	1482	1186	988	847	741	1581	1186	949	791	678	593	1482	1112	889	741	635	556	1318	988	791	659	565	494
18	2029	1522	1218	1015	870	761	1623	1218	974	812	696	609	1522	1142	913	761	652	571	1353	1015	812	676	580	507
18,5	2080	1560	1248	1040	891	780	1664	1248	998	832	713	624	1560	1170	936	780	668	585	1386	1040	832	693	594	520

LD 0 - Lopatka 0 długa
LD I - Lopatka I długa
LK 0 - Lopatka 0 krótka
LK I - Lopatka I krótka



Tabela wysiewu

SIPMA RN 610 ANTEK

Tarcza: 430

Lopatki I



NPK 4 - 12 - 20 Amofoska

Gdańskie Zakłady Nawozów Fosforowych "Fosfory" Sp. z o.o.

Formuła nawozu: NPK 4-12-20
Klasa ziarnowa: frakcja 2-5,5 mm, nie mniej niż 90%
Gęstość nasypowa: 1,19 kg/dm³

Szerokość robocza	20 m						21 m						24 m					
Typ i ustawienie lopatek	LD I - 2,2						LD I - 2,5						LD I - 3					
	LK I - 1,4						LK I - 2						LK I - 2					
Obroty	540 obr/min						540 obr/min						540 obr/min					
Dawka wysiewu	kg/ha																	
Nastawa	Prędk. robocza [km/h]						Prędk. robocza [km/h]						Prędk. robocza [km/h]					
	6	8	10	12	14	16	6	8	10	12	14	16	6	8	10	12	14	16
4	33	25	20	17	14	12	32	24	19	16	14	12	28	21	17	14	12	10
4,5	40	30	24	20	17	15	39	29	23	19	17	14	34	25	20	17	14	13
5	50	38	30	25	22	19	48	36	29	24	20	18	42	31	25	21	18	16
5,5	62	47	37	31	27	23	59	44	35	30	25	22	52	39	31	26	22	19
6	75	56	45	37	32	28	71	53	43	36	31	27	62	47	37	31	27	23
6,5	90	67	54	45	39	34	86	64	51	43	37	32	75	56	45	37	32	28
7	109	82	65	54	47	41	104	78	62	52	44	39	91	68	54	45	39	34
7,5	128	96	77	64	55	48	122	91	73	61	52	46	106	80	64	53	46	40
8	154	116	93	77	66	58	147	110	88	73	63	55	129	96	77	64	55	48
8,5	177	133	106	88	76	66	168	126	101	84	72	63	147	111	88	74	63	55
9	205	154	123	103	88	77	195	146	117	98	84	73	171	128	103	85	73	64
9,5	234	175	140	117	100	88	222	167	133	111	95	83	195	146	117	97	83	73
10	268	201	161	134	115	100	255	191	153	128	109	96	223	167	134	112	96	84
10,5	305	229	183	152	131	114	290	218	174	145	124	109	254	190	152	127	109	95
11	344	258	206	172	147	129	327	246	196	164	140	123	286	215	172	143	123	107
11,5	390	292	234	195	167	146	371	279	223	186	159	139	325	244	195	162	139	122
12	432	324	259	216	185	162	411	309	247	206	176	154	360	270	216	180	154	135
12,5	486	365	292	243	208	182	463	347	278	232	198	174	405	304	243	203	174	152
13	552	414	331	276	237	207	526	395	316	263	225	197	460	345	276	230	197	173
13,5	604	453	362	302	259	226	575	431	345	288	246	216	503	377	302	252	216	189
14	666	499	399	333	285	250	634	476	380	317	272	238	555	416	333	277	238	208
14,5	729	546	437	364	312	273	694	520	416	347	297	260	607	455	364	304	260	228
15	801	601	481	401	343	301	763	572	458	382	327	286	668	501	401	334	286	250
15,5	869	652	521	434	372	326	828	621	497	414	355	310	724	543	434	362	310	272
16	946	709	567	473	405	355	901	676	540	450	386	338	788	591	473	394	338	296
16,5	1051	788	630	525	450	394	1001	751	600	500	429	375	876	657	525	438	375	328
17	1122	842	673	561	481	421	1069	802	641	534	458	401	935	701	561	468	401	351
17,5	1186	889	712	593	508	445	1129	847	678	565	484	424	988	741	593	494	424	371
18	1218	913	731	609	522	457	1160	870	696	580	497	435	1015	761	609	507	435	381
18,5	1248	936	749	624	535	468	1188	891	713	594	509	446	1040	780	624	520	446	390

LD 0 - Lopatka 0 długa
LD I - Lopatka I długa
LK 0 - Lopatka 0 krótka
LK I - Lopatka I krótka



Tabela wysiewu

SIPMA RN 610 ANTEK

Tarcza: 430

Lopatkki 0



Super Fos Dar 40

Gdańskie Zakłady Nawozów Fosforowych "Fosfory" Sp. z o.o.

Formuła nawozu: P2O5 (CaO) 25(10)
Klasa ziarnowa: frakcja 2-5,5mm, nie mniej niż 90%
Gęstość nasypowa: 1,21 kg/dm³

Szerokość robocza	10 m						12 m						15 m						16 m						18 m					
Typ i ustawienie łopatek	LD 0 - 2						LD 0 - 2,1						LD 0 - 2,1						LD 0 - 2,2						LD 0 - 2,2					
	LK 0 - 2,2						LK 0 - 2,4						LK 0 - 3,1						LK 0 - 3,3						LK 0 - 4					
Obroty	540 obr/min						540 obr/min						540 obr/min						540 obr/min						540 obr/min					
Dawka wysiewu	kg/ha																													
Nastawa	Prędk. robocza [km/h]						Prędk. robocza [km/h]						Prędk. robocza [km/h]						Prędk. robocza [km/h]						Prędk. robocza [km/h]					
	6	8	10	12	14	16	6	8	10	12	14	16	6	8	10	12	14	16	6	8	10	12	14	16	6	8	10	12	14	16
4	86	64	51	43	37	32	72	54	43	36	31	27	57	43	34	29	25	21	54	40	32	27	23	20	48	36	29	24	20	18
4,5	108	81	65	54	46	41	90	68	54	45	39	34	72	54	43	36	31	27	68	51	41	34	29	25	60	45	36	30	26	23
5	133	100	80	67	57	50	111	83	67	56	48	42	89	67	53	44	38	33	83	63	50	42	36	31	74	56	44	37	32	28
5,5	161	121	97	81	69	60	134	101	81	67	58	50	107	81	64	54	46	40	101	76	60	50	43	38	90	67	54	45	38	34
6	196	147	118	98	84	73	163	122	98	82	70	61	131	98	78	65	56	49	122	92	73	61	52	46	109	82	65	54	47	41
6,5	233	175	140	117	100	87	194	146	117	97	83	73	155	117	93	78	67	58	146	109	87	73	62	55	129	97	78	65	55	49
7	285	214	171	143	122	107	238	178	143	119	102	89	190	143	114	95	81	71	178	134	107	89	76	67	158	119	95	79	68	59
7,5	330	248	198	165	141	124	275	206	165	138	118	103	220	165	132	110	94	83	206	155	124	103	88	77	183	138	110	92	79	69
8	388	291	233	194	166	145	323	242	194	162	139	121	259	194	155	129	111	97	242	182	145	121	104	91	215	162	129	108	92	81
8,5	450	337	270	225	193	169	375	281	225	187	161	141	300	225	180	150	128	112	281	211	169	141	120	105	250	187	150	125	107	94
9	518	388	311	259	222	194	431	324	259	216	185	162	345	259	207	173	148	129	324	243	194	162	139	121	288	216	173	144	123	108
9,5	594	446	357	297	255	223	495	371	297	248	212	186	396	297	238	198	170	149	371	279	223	186	159	139	330	248	198	165	141	124
10	673	505	404	337	289	252	561	421	337	281	240	210	449	337	269	224	192	168	421	316	252	210	180	158	374	281	224	187	160	140
10,5	776	582	466	388	333	291	647	485	388	323	277	243	517	388	310	259	222	194	485	364	291	243	208	182	431	323	259	216	185	162
11	865	649	519	432	371	324	721	541	432	360	309	270	577	432	346	288	247	216	541	405	324	270	232	203	480	360	288	240	206	180
11,5	963	722	578	481	413	361	802	602	481	401	344	301	642	481	385	321	275	241	602	451	361	301	258	226	535	401	321	267	229	201
12	1068	801	641	534	458	401	890	668	534	445	381	334	712	534	427	356	305	267	668	501	401	334	286	250	593	445	356	297	254	223
12,5	1193	895	716	597	511	448	994	746	597	497	426	373	796	597	477	398	341	298	746	559	448	373	320	280	663	497	398	331	284	249
13	1329	997	797	665	570	498	1108	831	665	554	475	415	886	665	532	443	380	332	831	623	498	415	356	312	738	554	443	369	316	277
13,5	1481	1111	889	740	635	555	1234	926	740	617	529	463	987	740	592	494	423	370	926	694	555	463	397	347	823	617	494	411	353	309
14	1627	1220	976	814	697	610	1356	1017	814	678	581	508	1085	814	651	542	465	407	1017	763	610	508	436	381	904	678	542	452	387	339
14,5	1755	1316	1053	878	752	658	1463	1097	878	731	627	549	1170	878	702	585	501	439	1097	823	658	549	470	411	975	731	585	488	418	366
15	1937	1453	1162	969	830	726	1614	1211	969	807	692	605	1291	969	775	646	553	484	1211	908	726	605	519	454	1076	807	646	538	461	404
15,5	2114	1585	1268	1057	906	793	1762	1321	1057	881	755	661	1409	1057	846	705	604	528	1321	991	793	661	566	495	1174	881	705	587	503	440
16	2291	1719	1375	1146	982	859	1910	1432	1146	955	818	716	1528	1146	917	764	655	573	1432	1074	859	716	614	537	1273	955	764	637	546	477
16,5	2535	1901	1521	1268	1086	951	2113	1584	1268	1056	905	792	1690	1268	1014	845	724	634	1584	1188	951	792	679	594	1408	1056	845	704	604	528
17	2700	2025	1620	1350	1157	1012	2250	1687	1350	1125	964	844	1800	1350	1080	900	771	675	1687	1266	1012	844	723	633	1500	1125	900	750	643	562
17,5	2871	2153	1722	1435	1230	1076	2392	1794	1435	1196	1025	897	1914	1435	1148	957	820	718	1794	1346	1076	897	769	673	1595	1196	957	797	683	598
18	2972	2229	1783	1486	1274	1114	2477	1857	1486	1238	1061	929	1981	1486	1189	991	849	743	1857	1393	1114	929	796	697	1651	1238	991	826	708	619
18,5	3039	2279	1823	1520	1302	1140	2533	1899	1520	1266	1085	950	2026	1520	1216	1013	868	760	1899	1425	1140	950	814	712	1688	1266	1013	844	724	633

LD 0 - Lopatka 0 długa
LD 1 - Lopatka I długa
LK 0 - Lopatka 0 krótka
LK 1 - Lopatka I krótka



Tabela wysiewu

SIPMA RN 610 ANTEK

Tarcza: 430

Lopatki I

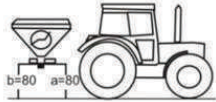

Super Fos Dar 40

Gdańskie Zakłady Nawozów Fosforowych "Fosfory" Sp. z o.o.

Formuła nawozu: P2O5 (CaO) 25(10)
Klasa ziarnowa: frakcja 2-5,5mm, nie mniej niż 90%
Gęstość nasypowa: 1,21 kg/dm³

Szerokość robocza	12 m						15 m						16 m						18 m					
Typ i ustawienie lopatek	LD I - 1,4						LD I - 2						LD I - 2						LD I - 2,2					
	LK I - 1,3						LK I - 1,4						LK I - 2,1						LK I - 2,3					
Obroty	540 obr/min						540 obr/min						540 obr/min						540 obr/min					
Dawka wysiewu	kg/ha																							
Nastawa	Prędk. robocza [km/h]						Prędk. robocza [km/h]						Prędk. robocza [km/h]						Prędk. robocza [km/h]					
	6	8	10	12	14	16	6	8	10	12	14	16	6	8	10	12	14	16	6	8	10	12	14	16
4	72	54	43	36	31	27	57	43	34	29	25	21	54	40	32	27	23	20	48	36	29	24	20	18
4,5	90	68	54	45	39	34	72	54	43	36	31	27	68	51	41	34	29	25	60	45	36	30	26	23
5	111	83	67	56	48	42	89	67	53	44	38	33	83	63	50	42	36	31	74	56	44	37	32	28
5,5	134	101	81	67	58	50	107	81	64	54	46	40	101	76	60	50	43	38	90	67	54	45	38	34
6	163	122	98	82	70	61	131	98	78	65	56	49	122	92	73	61	52	46	109	82	65	54	47	41
6,5	194	146	117	97	83	73	155	117	93	78	67	58	146	109	87	73	62	55	129	97	78	65	55	49
7	238	178	143	119	102	89	190	143	114	95	81	71	178	134	107	89	76	67	158	119	95	79	68	59
7,5	275	206	165	138	118	103	220	165	132	110	94	83	206	155	124	103	88	77	183	138	110	92	79	69
8	323	242	194	162	139	121	259	194	155	129	111	97	242	182	145	121	104	91	215	162	129	108	92	81
8,5	375	281	225	187	161	141	300	225	180	150	128	112	281	211	169	141	120	105	250	187	150	125	107	94
9	431	324	259	216	185	162	345	259	207	173	148	129	324	243	194	162	139	121	288	216	173	144	123	108
9,5	495	371	297	248	212	186	396	297	238	198	170	149	371	279	223	186	159	139	330	248	198	165	141	124
10	561	421	337	281	240	210	449	337	269	224	192	168	421	316	252	210	180	158	374	281	224	187	160	140
10,5	647	485	388	323	277	243	517	388	310	259	222	194	485	364	291	243	208	182	431	323	259	216	185	162
11	721	541	432	360	309	270	577	432	346	288	247	216	541	405	324	270	232	203	480	360	288	240	206	180
11,5	802	602	481	401	344	301	642	481	385	321	275	241	602	451	361	301	258	226	535	401	321	267	229	201
12	890	668	534	445	381	334	712	534	427	356	305	267	668	501	401	334	286	250	593	445	356	297	254	223
12,5	994	746	597	497	426	373	796	597	477	398	341	298	746	559	448	373	320	280	663	497	398	331	284	249
13	1108	831	665	554	475	415	886	665	532	443	380	332	831	623	498	415	356	312	738	554	443	369	316	277
13,5	1234	926	740	617	529	463	987	740	592	494	423	370	926	694	555	463	397	347	823	617	494	411	353	309
14	1356	1017	814	678	581	508	1085	814	651	542	465	407	1017	763	610	508	436	381	904	678	542	452	387	339
14,5	1463	1097	878	731	627	549	1170	878	702	585	501	439	1097	823	658	549	470	411	975	731	585	488	418	366
15	1614	1211	969	807	692	605	1291	969	775	646	553	484	1211	908	726	605	519	454	1076	807	646	538	461	404
15,5	1762	1321	1057	881	755	661	1409	1057	846	705	604	528	1321	991	793	661	566	495	1174	881	705	587	503	440
16	1910	1432	1146	955	818	716	1528	1146	917	764	655	573	1432	1074	859	716	614	537	1273	955	764	637	546	477
16,5	2113	1584	1268	1056	905	792	1690	1268	1014	845	724	634	1584	1188	951	792	679	594	1408	1056	845	704	604	528
17	2250	1687	1350	1125	964	844	1800	1350	1080	900	771	675	1687	1266	1012	844	723	633	1500	1125	900	750	643	562
17,5	2392	1794	1435	1196	1025	897	1914	1435	1148	957	820	718	1794	1346	1076	897	769	673	1595	1196	957	797	683	598
18	2477	1857	1486	1238	1061	929	1981	1486	1189	991	849	743	1857	1393	1114	929	796	697	1651	1238	991	826	708	619
18,5	2533	1899	1520	1266	1085	950	2026	1520	1216	1013	868	760	1899	1425	1140	950	814	712	1688	1266	1013	844	724	633

LD 0 - Lopatka 0 długa
LD I - Lopatka I długa
LK 0 - Lopatka 0 krótka
LK I - Lopatka I krótka



Tabela wysiewu

SIPMA RN 610 ANTEK

Tarcza: 430

Lopatki I



Super Fos Dar 40

Gdańskie Zakłady Nawozów Fosforowych "Fosfory" Sp. z o.o.

Formuła nawozu: P2O5 (CaO) 25(10)
Klasa ziarnowa: frakcja 2-5,5mm, nie mniej niż 90%
Gęstość nasypowa: 1,21 kg/dm³

Szerokość robocza	20 m						21 m						24 m					
Typ i ustawienie lopatek	LD I - 2,2						LD I - 2,4						LD I - 2,5					
	LK I - 3						LK I - 3						LK I - 3					
Obroty	540 obr/min						540 obr/min						540 obr/min					
Dawka wysiewu	kg/ha																	
Nastawa	Prędk. robocza [km/h]						Prędk. robocza [km/h]						Prędk. robocza [km/h]					
	6	8	10	12	14	16	6	8	10	12	14	16	6	8	10	12	14	16
4	43	32	26	21	18	16	41	31	25	20	18	15	36	27	21	18	15	13
4,5	54	41	33	27	23	20	52	39	31	26	22	19	45	34	27	23	19	17
5	67	50	40	33	29	25	63	48	38	32	27	24	56	42	33	28	24	21
5,5	81	60	48	40	35	30	77	58	46	38	33	29	67	50	40	34	29	25
6	98	73	59	49	42	37	93	70	56	47	40	35	82	61	49	41	35	31
6,5	117	87	70	58	50	44	111	83	67	55	48	42	97	73	58	49	42	36
7	143	107	86	71	61	53	136	102	81	68	58	51	119	89	71	59	51	45
7,5	165	124	99	83	71	62	157	118	94	79	67	59	138	103	83	69	59	52
8	194	145	116	97	83	73	185	139	111	92	79	69	162	121	97	81	69	61
8,5	225	169	135	112	96	84	214	161	128	107	92	80	187	141	112	94	80	70
9	259	194	155	129	111	97	246	185	148	123	106	92	216	162	129	108	92	81
9,5	297	223	178	149	127	111	283	212	170	141	121	106	248	186	149	124	106	93
10	337	252	202	168	144	126	321	240	192	160	137	120	281	210	168	140	120	105
10,5	388	291	233	194	166	146	370	277	222	185	158	139	323	243	194	162	139	121
11	432	324	259	216	185	162	412	309	247	206	176	154	360	270	216	180	154	135
11,5	481	361	289	241	206	181	458	344	275	229	196	172	401	301	241	201	172	150
12	534	401	320	267	229	200	509	381	305	254	218	191	445	334	267	223	191	167
12,5	597	448	358	298	256	224	568	426	341	284	244	213	497	373	298	249	213	186
13	665	498	399	332	285	249	633	475	380	316	271	237	554	415	332	277	237	208
13,5	740	555	444	370	317	278	705	529	423	353	302	264	617	463	370	309	264	231
14	814	610	488	407	349	305	775	581	465	387	332	291	678	508	407	339	291	254
14,5	878	658	527	439	376	329	836	627	501	418	358	313	731	549	439	366	313	274
15	969	726	581	484	415	363	922	692	553	461	395	346	807	605	484	404	346	303
15,5	1057	793	634	528	453	396	1007	755	604	503	431	377	881	661	528	440	377	330
16	1146	859	687	573	491	430	1091	818	655	546	468	409	955	716	573	477	409	358
16,5	1268	951	761	634	543	475	1207	905	724	604	517	453	1056	792	634	528	453	396
17	1350	1012	810	675	579	506	1286	964	771	643	551	482	1125	844	675	562	482	422
17,5	1435	1076	861	718	615	538	1367	1025	820	683	586	513	1196	897	718	598	513	449
18	1486	1114	892	743	637	557	1415	1061	849	708	606	531	1238	929	743	619	531	464
18,5	1520	1140	912	760	651	570	1447	1085	868	724	620	543	1266	950	760	633	543	475

- LD 0 - Lopatka 0 długa
- LD I - Lopatka I długa
- LK 0 - Lopatka 0 krótka
- LK I - Lopatka I krótka



Tabela wysiewu

SIPMA RN 610 ANTEK

Tarcza: 430

Lopatkı 0



NPK 4 - 12 - 32 Polifoska 4

Grupa Azoty Zakłady Chemiczne „Police” S.A.

Formuła nawozu: NPK(MgS) 4-12-32-(2-9)
Klasa ziarnowa: granule 2-5 mm, nie mniej niż 92%
Gęstość nasypowa: 0,9-1,0 kg/dm³

Szerokość robocza	10 m						15 m						16 m						18 m						20 m					
Typ i ustawienie łopatek	LD 0 - 1,1						LD 0 - 1,3						LD 0 - 2						LD 0 - 2,2						LD 0 - 2,3					
	LK 0 - 0,2						LK 0 - 1						LK 0 - 1,2						LK 0 - 2,2						LK 0 - 2,4					
Obroty	540 obr/min						540 obr/min						540 obr/min						540 obr/min						540 obr/min					
Dawka wysiewu	kg/ha																													
Nastawa	Prędk. robocza [km/h]						Prędk. robocza [km/h]						Prędk. robocza [km/h]						Prędk. robocza [km/h]						Prędk. robocza [km/h]					
	6	8	10	12	14	16	6	8	10	12	14	16	6	8	10	12	14	16	6	8	10	12	14	16	6	8	10	12	14	16
4	85	64	51	43	37	32	57	43	34	28	24	21	53	40	32	27	23	20	47	36	28	24	20	18	43	32	26	21	18	16
4,5	106	79	63	53	45	40	71	53	42	35	30	26	66	50	40	33	28	25	59	44	35	29	25	22	53	40	32	26	23	20
5	131	98	78	65	56	49	87	65	52	44	37	33	82	61	49	41	35	31	73	54	44	36	31	27	65	49	39	33	28	25
5,5	161	121	97	81	69	60	107	81	64	54	46	40	101	75	60	50	43	38	89	67	54	45	38	34	81	60	48	40	35	30
6	193	144	116	96	83	72	128	96	77	64	55	48	120	90	72	60	52	45	107	80	64	54	46	40	96	72	58	48	41	36
6,5	231	174	139	116	99	87	154	116	93	77	66	58	145	108	87	72	62	54	129	96	77	64	55	48	116	87	69	58	50	43
7	271	203	162	135	116	102	180	135	108	90	77	68	169	127	102	85	73	63	150	113	90	75	64	56	135	102	81	68	58	51
7,5	319	239	191	160	137	120	213	160	128	106	91	80	199	150	120	100	85	75	177	133	106	89	76	66	160	120	96	80	68	60
8	370	278	222	185	159	139	247	185	148	123	106	93	232	174	139	116	99	87	206	154	123	103	88	77	185	139	111	93	79	69
8,5	431	323	259	216	185	162	287	216	172	144	123	108	269	202	162	135	115	101	240	180	144	120	103	90	216	162	129	108	92	81
9	495	372	297	248	212	186	330	248	198	165	142	124	310	232	186	155	133	116	275	206	165	138	118	103	248	186	149	124	106	93
9,5	566	424	340	283	243	212	377	283	226	189	162	141	354	265	212	177	152	133	314	236	189	157	135	118	283	212	170	141	121	106
10	640	480	384	320	274	240	427	320	256	213	183	160	400	300	240	200	171	150	356	267	213	178	152	133	320	240	192	160	137	120
10,5	726	544	435	363	311	272	484	363	290	242	207	181	454	340	272	227	194	170	403	302	242	202	173	151	363	272	218	181	156	136
11	811	608	487	405	348	304	541	405	324	270	232	203	507	380	304	253	217	190	451	338	270	225	193	169	405	304	243	203	174	152
11,5	893	670	536	446	383	335	595	446	357	298	255	223	558	418	335	279	239	209	496	372	298	248	213	186	446	335	268	223	191	167
12	1008	756	605	504	432	378	672	504	403	336	288	252	630	473	378	315	270	236	560	420	336	280	240	210	504	378	302	252	216	189
12,5	1110	832	666	555	476	416	740	555	444	370	317	277	694	520	416	347	297	260	617	462	370	308	264	231	555	416	333	277	238	208
13	1235	926	741	618	529	463	823	618	494	412	353	309	772	579	463	386	331	290	686	515	412	343	294	257	618	463	371	309	265	232
13,5	1362	1022	817	681	584	511	908	681	545	454	389	341	852	639	511	426	365	319	757	568	454	378	324	284	681	511	409	341	292	255
14	1495	1121	897	748	641	561	997	748	598	498	427	374	935	701	561	467	401	350	831	623	498	415	356	312	748	561	449	374	320	280
14,5	1599	1199	959	799	685	599	1066	799	639	533	457	400	999	749	599	500	428	375	888	666	533	444	381	333	799	599	480	400	343	300
15	1755	1316	1053	878	752	658	1170	878	702	585	501	439	1097	823	658	548	470	411	975	731	585	488	418	366	878	658	527	439	376	329
15,5	1880	1410	1128	940	806	705	1253	940	752	627	537	470	1175	881	705	588	504	441	1045	783	627	522	448	392	940	705	564	470	403	353
16	2117	1588	1270	1059	907	794	1411	1059	847	706	605	529	1323	992	794	662	567	496	1176	882	706	588	504	441	1059	794	635	529	454	397
16,5	2268	1701	1361	1134	972	851	1512	1134	907	756	648	567	1418	1063	851	709	608	532	1260	945	756	630	540	473	1134	851	681	567	486	425
17	2451	1838	1470	1225	1050	919	1634	1225	980	817	700	613	1532	1149	919	766	656	574	1362	1021	817	681	584	511	1225	919	735	613	525	460
17,5	2583	1937	1550	1291	1107	969	1722	1291	1033	861	738	646	1614	1211	969	807	692	605	1435	1076	861	717	615	538	1291	969	775	646	553	484
18	2669	2002	1601	1334	1144	1001	1779	1334	1068	890	763	667	1668	1251	1001	834	715	626	1483	1112	890	741	635	556	1334	1001	801	667	572	500
18,5	2690	2018	1614	1345	1153	1009	1793	1345	1076	897	769	673	1681	1261	1009	841	721	631	1495	1121	897	747	641	560	1345	1009	807	673	576	504

LD 0 - Łopatkę 0 długa
LD 1 - Łopatkę 1 długa
LK 0 - Łopatkę 0 krótka
LK 1 - Łopatkę 1 krótka



Tabela wysiewu

SIPMA RN 610 ANTEK

Tarcza: 430

Lopatki I

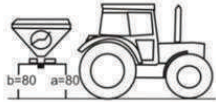

NPK 4 - 12 - 32 Polifoska 4

Grupa Azoty Zakłady Chemiczne „Police” S.A.

Formuła nawozu: NPK(MgS) 4-12-32-(2-9)
Klasa ziarnowa: granule 2-5 mm, nie mniej niż 92%
Gęstość nasypowa: 0,9-1,0 kg/dm³

Szerokość robocza	12 m						15 m						16 m						18 m					
Typ i ustawienie lopatek	LD I - 1,3						LD I - 1,5						LD I - 1,5						LD I - 2,2					
	LK I - 1,3						LK I - 2						LK I - 2,3						LK I - 2,2					
Obroty	540 obr/min						540 obr/min						540 obr/min						540 obr/min					
Dawka wysiewu	kg/ha																							
Nastawa	Prędk. robocza [km/h]						Prędk. robocza [km/h]						Prędk. robocza [km/h]						Prędk. robocza [km/h]					
	6	8	10	12	14	16	6	8	10	12	14	16	6	8	10	12	14	16	6	8	10	12	14	16
4	65	49	39	32	28	24	52	39	31	26	22	19	49	36	29	24	21	18	43	32	26	22	19	16
4,5	82	61	49	41	35	31	65	49	39	33	28	25	61	46	37	31	26	23	55	41	33	27	23	20
5	99	74	60	50	43	37	79	60	48	40	34	30	74	56	45	37	32	28	66	50	40	33	28	25
5,5	119	89	71	59	51	44	95	71	57	47	41	36	89	67	53	44	38	33	79	59	47	40	34	30
6	143	107	86	71	61	54	114	86	69	57	49	43	107	80	64	54	46	40	95	71	57	48	41	36
6,5	172	129	103	86	74	65	138	103	83	69	59	52	129	97	77	65	55	48	115	86	69	57	49	43
7	201	151	121	101	86	75	161	121	97	80	69	60	151	113	91	75	65	57	134	101	80	67	57	50
7,5	243	182	146	122	104	91	194	146	117	97	83	73	182	137	109	91	78	68	162	122	97	81	69	61
8	283	212	170	141	121	106	226	170	136	113	97	85	212	159	127	106	91	80	189	141	113	94	81	71
8,5	331	248	199	166	142	124	265	199	159	133	114	99	248	186	149	124	106	93	221	166	133	110	95	83
9	377	283	226	188	162	141	302	226	181	151	129	113	283	212	170	141	121	106	251	188	151	126	108	94
9,5	432	324	259	216	185	162	346	259	208	173	148	130	324	243	195	162	139	122	288	216	173	144	124	108
10	497	372	298	248	213	186	397	298	238	199	170	149	372	279	223	186	160	140	331	248	199	166	142	124
10,5	561	421	336	280	240	210	449	336	269	224	192	168	421	315	252	210	180	158	374	280	224	187	160	140
11	619	464	372	310	265	232	495	372	297	248	212	186	464	348	279	232	199	174	413	310	248	206	177	155
11,5	697	523	418	348	299	261	558	418	335	279	239	209	523	392	314	261	224	196	465	348	279	232	199	174
12	787	590	472	394	337	295	630	472	378	315	270	236	590	443	354	295	253	221	525	394	315	262	225	197
12,5	862	647	517	431	369	323	690	517	414	345	296	259	647	485	388	323	277	242	575	431	345	287	246	216
13	953	715	572	476	408	357	762	572	457	381	327	286	715	536	429	357	306	268	635	476	381	318	272	238
13,5	1053	790	632	526	451	395	842	632	505	421	361	316	790	592	474	395	338	296	702	526	421	351	301	263
14	1169	877	702	585	501	439	935	702	561	468	401	351	877	658	526	439	376	329	780	585	468	390	334	292
14,5	1284	963	770	642	550	481	1027	770	616	513	440	385	963	722	578	481	413	361	856	642	513	428	367	321
15	1402	1052	841	701	601	526	1122	841	673	561	481	421	1052	789	631	526	451	394	935	701	561	467	401	351
15,5	1528	1146	917	764	655	573	1222	917	733	611	524	458	1146	859	687	573	491	430	1018	764	611	509	436	382
16	1667	1250	1000	833	714	625	1333	1000	800	667	571	500	1250	938	750	625	536	469	1111	833	667	556	476	417
16,5	1781	1336	1069	891	763	668	1425	1069	855	712	611	534	1336	1002	801	668	572	501	1187	891	712	594	509	445
17	1942	1457	1165	971	832	728	1554	1165	932	777	666	583	1457	1092	874	728	624	546	1295	971	777	647	555	486
17,5	2056	1542	1234	1028	881	771	1645	1234	987	823	705	617	1542	1157	925	771	661	578	1371	1028	823	685	588	514
18	2115	1587	1269	1058	907	793	1692	1269	1015	846	725	635	1587	1190	952	793	680	595	1410	1058	846	705	604	529
18,5	37758	28318	22655	18879	16182	14159	30206	22655	18124	15103	12945	11327	28318	21239	16991	14159	12136	10619	25172	18879	15103	12586	10788	9439

LD 0 - Lopatka 0 długa
LD I - Lopatka I długa
LK 0 - Lopatka 0 krótka
LK I - Lopatka I krótka



Tabela wysiewu

SIPMA RN 610 ANTEK

Tarcza: 430

Lopatki I



NPK 4 - 12 - 32 Polifoska 4

Grupa Azoty Zakłady Chemiczne „Police” S.A.

Formuła nawozu: NPK(MgS) 4-12-32-(2-9)
Klasa ziarnowa: granule 2-5 mm, nie mniej niż 92%
Gęstość nasypowa: 0,9-1,0 kg/dm³

Szerokość robocza	20 m						21 m						24 m					
Typ i ustawienie łopatek	LD I - 2,4						LD I - 3						LD I - 3,1					
	LK I - 2,2						LK I - 2,4						LK I - 2,2					
Obroty	540 obr/min						540 obr/min						540 obr/min					
Dawka wysiewu	kg/ha																	
Nastawa	Prędk. robocza [km/h]						Prędk. robocza [km/h]						Prędk. robocza [km/h]					
	6	8	10	12	14	16	6	8	10	12	14	16	6	8	10	12	14	16
4	39	29	23	19	17	15	37	28	22	19	16	14	32	24	19	16	14	12
4,5	49	37	29	25	21	18	47	35	28	23	20	18	41	31	25	20	18	15
5	60	45	36	30	26	22	57	43	34	28	24	21	50	37	30	25	21	19
5,5	71	53	43	36	31	27	68	51	41	34	29	25	59	44	36	30	25	22
6	86	64	51	43	37	32	82	61	49	41	35	31	71	54	43	36	31	27
6,5	103	77	62	52	44	39	98	74	59	49	42	37	86	65	52	43	37	32
7	121	91	72	60	52	45	115	86	69	57	49	43	101	75	60	50	43	38
7,5	146	109	87	73	62	55	139	104	83	69	60	52	122	91	73	61	52	46
8	170	127	102	85	73	64	162	121	97	81	69	61	141	106	85	71	61	53
8,5	199	149	119	99	85	75	189	142	114	95	81	71	166	124	99	83	71	62
9	226	170	136	113	97	85	215	162	129	108	92	81	188	141	113	94	81	71
9,5	259	195	156	130	111	97	247	185	148	124	106	93	216	162	130	108	93	81
10	298	223	179	149	128	112	284	213	170	142	122	106	248	186	149	124	106	93
10,5	336	252	202	168	144	126	320	240	192	160	137	120	280	210	168	140	120	105
11	372	279	223	186	159	139	354	265	212	177	152	133	310	232	186	155	133	116
11,5	418	314	251	209	179	157	398	299	239	199	171	149	348	261	209	174	149	131
12	472	354	283	236	202	177	450	337	270	225	193	169	394	295	236	197	169	148
12,5	517	388	310	259	222	194	493	369	296	246	211	185	431	323	259	216	185	162
13	572	429	343	286	245	214	545	408	327	272	233	204	476	357	286	238	204	179
13,5	632	474	379	316	271	237	602	451	361	301	258	226	526	395	316	263	226	197
14	702	526	421	351	301	263	668	501	401	334	286	251	585	439	351	292	251	219
14,5	770	578	462	385	330	289	733	550	440	367	314	275	642	481	385	321	275	241
15	841	631	505	421	361	315	801	601	481	401	343	300	701	526	421	351	300	263
15,5	917	687	550	458	393	344	873	655	524	436	374	327	764	573	458	382	327	286
16	1000	750	600	500	429	375	952	714	571	476	408	357	833	625	500	417	357	313
16,5	1069	801	641	534	458	401	1018	763	611	509	436	382	891	668	534	445	382	334
17	1165	874	699	583	499	437	1110	832	666	555	476	416	971	728	583	486	416	364
17,5	1234	925	740	617	529	463	1175	881	705	588	504	441	1028	771	617	514	441	386
18	1269	952	762	635	544	476	1209	907	725	604	518	453	1058	793	635	529	453	397
18,5	22655	16991	13593	11327	9709	8495	21576	16182	12945	10788	9247	8091	18879	14159	11327	9439	8091	7080

LD 0 - Łopaska 0 długa
LD 1 - Łopaska I długa
LK 0 - Łopaska 0 krótka
LK 1 - Łopaska I krótka



Tabela wysiewu

SIPMA RN 610 ANTEK

Tarcza: 430

Lopatkki 0



NPK 6 - 20 - 30 Polifoska 6

Grupa Azoty Zakłady Chemiczne „Police” S.A.

Formuła nawozu: NPK(S) 6-20-30-(7)
Klasa ziarnowa: granule 2-5 mm, nie mniej niż 92%
Gęstość nasypowa: 0,9-1,0 kg/dm³

Szerokość robocza	10 m						12 m						15 m						16 m						18 m					
Typ i ustawienie lopatek	LD 0 - 2,5						LD 0 - 2,5						LD 0 - 3						LD 0 - 3,2						LD 0 - 3,4					
	LK 0 - 2						LK 0 - 2,2						LK 0 - 2,2						LK 0 - 2						LK 0 - 2,2					
Obroty	540 obr/min						540 obr/min						540 obr/min						540 obr/min						540 obr/min					
Dawka wysiewu	kg/ha																													
Nastawa	Prędk. robocza [km/h]						Prędk. robocza [km/h]						Prędk. robocza [km/h]						Prędk. robocza [km/h]						Prędk. robocza [km/h]					
	6	8	10	12	14	16	6	8	10	12	14	16	6	8	10	12	14	16	6	8	10	12	14	16	6	8	10	12	14	16
4	78	58	47	39	33	29	65	49	39	32	28	24	52	39	31	26	22	19	49	36	29	24	21	18	43	32	26	22	19	16
4,5	98	74	59	49	42	37	82	61	49	41	35	31	65	49	39	33	28	25	61	46	37	31	26	23	55	41	33	27	23	20
5	119	89	71	60	51	45	99	74	60	50	43	37	79	60	48	40	34	30	74	56	45	37	32	28	66	50	40	33	28	25
5,5	142	107	85	71	61	53	119	89	71	59	51	44	95	71	57	47	41	36	89	67	53	44	38	33	79	59	47	40	34	30
6	172	129	103	86	74	64	143	107	86	71	61	54	114	86	69	57	49	43	107	80	64	54	46	40	95	71	57	48	41	36
6,5	207	155	124	103	89	77	172	129	103	86	74	65	138	103	83	69	59	52	129	97	77	65	55	48	115	86	69	57	49	43
7	241	181	145	121	103	91	201	151	121	101	86	75	161	121	97	80	69	60	151	113	91	75	65	57	134	101	80	67	57	50
7,5	292	219	175	146	125	109	243	182	146	122	104	91	194	146	117	97	83	73	182	137	109	91	78	68	162	122	97	81	69	61
8	339	255	204	170	145	127	283	212	170	141	121	106	226	170	136	113	97	85	212	159	127	106	91	80	189	141	113	94	81	71
8,5	398	298	239	199	170	149	331	248	199	166	142	124	265	199	159	133	114	99	248	186	149	124	106	93	221	166	133	110	95	83
9	452	339	271	226	194	170	377	283	226	188	162	141	302	226	181	151	129	113	283	212	170	141	121	106	251	188	151	126	108	94
9,5	519	389	311	259	222	195	432	324	259	216	185	162	346	259	208	173	148	130	324	243	195	162	139	122	288	216	173	144	124	108
10	596	447	358	298	255	223	497	372	298	248	213	186	397	298	238	199	170	149	372	279	223	186	160	140	331	248	199	166	142	124
10,5	673	505	404	336	288	252	561	421	336	280	240	210	449	336	269	224	192	168	421	315	252	210	180	158	374	280	224	187	160	140
11	743	557	446	372	318	279	619	464	372	310	265	232	495	372	297	248	212	186	464	348	279	232	199	174	413	310	248	206	177	155
11,5	836	627	502	418	358	314	697	523	418	348	299	261	558	418	335	279	239	209	523	392	314	261	224	196	465	348	279	232	199	174
12	945	709	567	472	405	354	787	590	472	394	337	295	630	472	378	315	270	236	590	443	354	295	253	221	525	394	315	262	225	197
12,5	1034	776	621	517	443	388	862	647	517	431	369	323	690	517	414	345	296	259	647	485	388	323	277	242	575	431	345	287	246	216
13	1143	858	686	572	490	429	953	715	572	476	408	357	762	572	457	381	327	286	715	536	429	357	306	268	635	476	381	318	272	238
13,5	1263	948	758	632	541	474	1053	790	632	526	451	395	842	632	505	421	361	316	790	592	474	395	338	296	702	526	421	351	301	263
14	1403	1052	842	702	601	526	1169	877	702	585	501	439	935	702	561	468	401	351	877	658	526	439	376	329	780	585	468	390	334	292
14,5	1540	1155	924	770	660	578	1284	963	770	642	550	481	1027	770	616	513	440	385	963	722	578	481	413	361	856	642	513	428	367	321
15	1682	1262	1009	841	721	631	1402	1052	841	701	601	526	1122	841	673	561	481	421	1052	789	631	526	451	394	935	701	561	467	401	351
15,5	1833	1375	1100	917	786	687	1528	1146	917	764	655	573	1222	917	733	611	524	458	1146	859	687	573	491	430	1018	764	611	509	436	382
16	2000	1500	1200	1000	857	750	1667	1250	1000	833	714	625	1333	1000	800	667	571	500	1250	938	750	625	536	469	1111	833	667	556	476	417
16,5	2137	1603	1282	1069	916	801	1781	1336	1069	891	763	668	1425	1069	855	712	611	534	1336	1002	801	668	572	501	1187	891	712	594	509	445
17	2330	1748	1398	1165	999	874	1942	1457	1165	971	832	728	1554	1165	932	777	666	583	1457	1092	874	728	624	546	1295	971	777	647	555	486
17,5	2468	1851	1481	1234	1058	925	2056	1542	1234	1028	881	771	1645	1234	987	823	705	617	1542	1157	925	771	661	578	1371	1028	823	685	588	514
18	2538	1904	1523	1269	1088	952	2115	1587	1269	1058	907	793	1692	1269	1015	846	725	635	1587	1190	952	793	680	595	1410	1058	846	705	604	529
18,5	45309	33982	27185	22655	19418	16991	37758	28318	22655	18879	16182	14159	30206	22655	18124	15103	12945	11327	28318	21239	16991	14159	12136	10619	25172	18879	15103	12586	10788	9439

- LD 0 - Lopatka 0 długa
- LD 1 - Lopatka I długa
- LK 0 - Lopatka 0 krótka
- LK 1 - Lopatka I krótka



Tabela wysiewu

SIPMA RN 610 ANTEK

Tarcza: 430

Lopatki I



NPK 6 - 20 - 30 Polifoska 6

Grupa Azoty Zakłady Chemiczne „Police” S.A.

Formuła nawozu: NPK(S) 6-20-30-(7)
Klasa ziarnowa: granule 2-5 mm, nie mniej niż 92%
Gęstość nasypowa: 0,9-1,0 kg/dm³

Szerokość robocza	12 m						15 m						16 m						18 m					
Typ i ustawienie lopatek	LD I - 1,3						LD I - 1,5						LD I - 1,5						LD I - 2,2					
	LK I - 1,3						LK I - 2						LK I - 2,3						LK I - 2,2					
Obroty	540 obr/min						540 obr/min						540 obr/min						540 obr/min					
Dawka wysiewu	kg/ha																							
Nastawa	Prędk. robocza [km/h]						Prędk. robocza [km/h]						Prędk. robocza [km/h]						Prędk. robocza [km/h]					
	6	8	10	12	14	16	6	8	10	12	14	16	6	8	10	12	14	16	6	8	10	12	14	16
4	65	49	39	32	28	24	52	39	31	26	22	19	49	36	29	24	21	18	43	32	26	22	19	16
4,5	82	61	49	41	35	31	65	49	39	33	28	25	61	46	37	31	26	23	55	41	33	27	23	20
5	99	74	60	50	43	37	79	60	48	40	34	30	74	56	45	37	32	28	66	50	40	33	28	25
5,5	119	89	71	59	51	44	95	71	57	47	41	36	89	67	53	44	38	33	79	59	47	40	34	30
6	143	107	86	71	61	54	114	86	69	57	49	43	107	80	64	54	46	40	95	71	57	48	41	36
6,5	172	129	103	86	74	65	138	103	83	69	59	52	129	97	77	65	55	48	115	86	69	57	49	43
7	201	151	121	101	86	75	161	121	97	80	69	60	151	113	91	75	65	57	134	101	80	67	57	50
7,5	243	182	146	122	104	91	194	146	117	97	83	73	182	137	109	91	78	68	162	122	97	81	69	61
8	283	212	170	141	121	106	226	170	136	113	97	85	212	159	127	106	91	80	189	141	113	94	81	71
8,5	331	248	199	166	142	124	265	199	159	133	114	99	248	186	149	124	106	93	221	166	133	110	95	83
9	377	283	226	188	162	141	302	226	181	151	129	113	283	212	170	141	121	106	251	188	151	126	108	94
9,5	432	324	259	216	185	162	346	259	208	173	148	130	324	243	195	162	139	122	288	216	173	144	124	108
10	497	372	298	248	213	186	397	298	238	199	170	149	372	279	223	186	160	140	331	248	199	166	142	124
10,5	561	421	336	280	240	210	449	336	269	224	192	168	421	315	252	210	180	158	374	280	224	187	160	140
11	619	464	372	310	265	232	495	372	297	248	212	186	464	348	279	232	199	174	413	310	248	206	177	155
11,5	697	523	418	348	299	261	558	418	335	279	239	209	523	392	314	261	224	196	465	348	279	232	199	174
12	787	590	472	394	337	295	630	472	378	315	270	236	590	443	354	295	253	221	525	394	315	262	225	197
12,5	862	647	517	431	369	323	690	517	414	345	296	259	647	485	388	323	277	242	575	431	345	287	246	216
13	953	715	572	476	408	357	762	572	457	381	327	286	715	536	429	357	306	268	635	476	381	318	272	238
13,5	1053	790	632	526	451	395	842	632	505	421	361	316	790	592	474	395	338	296	702	526	421	351	301	263
14	1169	877	702	585	501	439	935	702	561	468	401	351	877	658	526	439	376	329	780	585	468	390	334	292
14,5	1284	963	770	642	550	481	1027	770	616	513	440	385	963	722	578	481	413	361	856	642	513	428	367	321
15	1402	1052	841	701	601	526	1122	841	673	561	481	421	1052	789	631	526	451	394	935	701	561	467	401	351
15,5	1528	1146	917	764	655	573	1222	917	733	611	524	458	1146	859	687	573	491	430	1018	764	611	509	436	382
16	1667	1250	1000	833	714	625	1333	1000	800	667	571	500	1250	938	750	625	536	469	1111	833	667	556	476	417
16,5	1781	1336	1069	891	763	668	1425	1069	855	712	611	534	1336	1002	801	668	572	501	1187	891	712	594	509	445
17	1942	1457	1165	971	832	728	1554	1165	932	777	666	583	1457	1092	874	728	624	546	1295	971	777	647	555	486
17,5	2056	1542	1234	1028	881	771	1645	1234	987	823	705	617	1542	1157	925	771	661	578	1371	1028	823	685	588	514
18	2115	1587	1269	1058	907	793	1692	1269	1015	846	725	635	1587	1190	952	793	680	595	1410	1058	846	705	604	529
18,5	37758	28318	22655	18879	16182	14159	30206	22655	18124	15103	12945	11327	28318	21239	16991	14159	12136	10619	25172	18879	15103	12586	10788	9439

LD 0 - Lopatka 0 długa
LD I - Lopatka I długa
LK 0 - Lopatka 0 krótka
LK I - Lopatka I krótka



Tabela wysiewu

SIPMA RN 610 ANTEK

Tarcza: 430

Lopatki I



NPK 6 - 20 - 30 Polifoska 6

Grupa Azoty Zakłady Chemiczne „Police” S.A.

Formuła nawozu: NPK(S) 6-20-30-(7)
Klasa ziarnowa: granule 2-5 mm, nie mniej niż 92%
Gęstość nasypowa: 0,9-1,0 kg/dm³

Szerokość robocza	20 m						21 m						24 m					
Typ i ustawienie łopatek	LD I - 2,4						LD I - 3						LD I - 3,1					
	LK I - 2,2						LK I - 2,4						LK I - 2,2					
Obroty	540 obr/min						540 obr/min						540 obr/min					
Dawka wysiewu	kg/ha																	
Nastawa	Prędk. robocza [km/h]						Prędk. robocza [km/h]						Prędk. robocza [km/h]					
	6	8	10	12	14	16	6	8	10	12	14	16	6	8	10	12	14	16
4	39	29	23	19	17	15	37	28	22	19	16	14	32	24	19	16	14	12
4,5	49	37	29	25	21	18	47	35	28	23	20	18	41	31	25	20	18	15
5	60	45	36	30	26	22	57	43	34	28	24	21	50	37	30	25	21	19
5,5	71	53	43	36	31	27	68	51	41	34	29	25	59	44	36	30	25	22
6	86	64	51	43	37	32	82	61	49	41	35	31	71	54	43	36	31	27
6,5	103	77	62	52	44	39	98	74	59	49	42	37	86	65	52	43	37	32
7	121	91	72	60	52	45	115	86	69	57	49	43	101	75	60	50	43	38
7,5	146	109	87	73	62	55	139	104	83	69	60	52	122	91	73	61	52	46
8	170	127	102	85	73	64	162	121	97	81	69	61	141	106	85	71	61	53
8,5	199	149	119	99	85	75	189	142	114	95	81	71	166	124	99	83	71	62
9	226	170	136	113	97	85	215	162	129	108	92	81	188	141	113	94	81	71
9,5	259	195	156	130	111	97	247	185	148	124	106	93	216	162	130	108	93	81
10	298	223	179	149	128	112	284	213	170	142	122	106	248	186	149	124	106	93
10,5	336	252	202	168	144	126	320	240	192	160	137	120	280	210	168	140	120	105
11	372	279	223	186	159	139	354	265	212	177	152	133	310	232	186	155	133	116
11,5	418	314	251	209	179	157	398	299	239	199	171	149	348	261	209	174	149	131
12	472	354	283	236	202	177	450	337	270	225	193	169	394	295	236	197	169	148
12,5	517	388	310	259	222	194	493	369	296	246	211	185	431	323	259	216	185	162
13	572	429	343	286	245	214	545	408	327	272	233	204	476	357	286	238	204	179
13,5	632	474	379	316	271	237	602	451	361	301	258	226	526	395	316	263	226	197
14	702	526	421	351	301	263	668	501	401	334	286	251	585	439	351	292	251	219
14,5	770	578	462	385	330	289	733	550	440	367	314	275	642	481	385	321	275	241
15	841	631	505	421	361	315	801	601	481	401	343	300	701	526	421	351	300	263
15,5	917	687	550	458	393	344	873	655	524	436	374	327	764	573	458	382	327	286
16	1000	750	600	500	429	375	952	714	571	476	408	357	833	625	500	417	357	313
16,5	1069	801	641	534	458	401	1018	763	611	509	436	382	891	668	534	445	382	334
17	1165	874	699	583	499	437	1110	832	666	555	476	416	971	728	583	486	416	364
17,5	1234	925	740	617	529	463	1175	881	705	588	504	441	1028	771	617	514	441	386
18	1269	952	762	635	544	476	1209	907	725	604	518	453	1058	793	635	529	453	397
18,5	22655	16991	13593	11327	9709	8495	21576	16182	12945	10788	9247	8091	18879	14159	11327	9439	8091	7080

LD 0 - Łopaska 0 długa
LD 1 - Łopaska 1 długa
LK 0 - Łopaska 0 krótka
LK 1 - Łopaska 1 krótka



Tabela wysiewu

SIPMA RN 610 ANTEK

Tarcza: 430

Lopatki 0



NPK 8 - 24 - 24 Polifoska 8

Grupa Azoty Zakłady Chemiczne „Police” S.A.

Formuła nawozu: NPK(S) 6-20-30-(7)
Klasa ziarnowa: granule 2-5 mm, nie mniej niż 92%
Gęstość nasypowa: 0,9-1,0 kg/dm³

Szerokość robocza	10 m						12 m						15 m						16 m						18 m					
Typ i ustawienie lopatek	LD 0 - 2,5						LD 0 - 2,5						LD 0 - 3						LD 0 - 3,2						LD 0 - 3,4					
	LK 0 - 2						LK 0 - 2,2						LK 0 - 2,2						LK 0 - 2						LK 0 - 2,2					
Obroty	540 obr/min						540 obr/min						540 obr/min						540 obr/min						540 obr/min					
Dawka wysiewu	kg/ha																													
Nastawa	Prędk. robocza [km/h]						Prędk. robocza [km/h]						Prędk. robocza [km/h]						Prędk. robocza [km/h]						Prędk. robocza [km/h]					
	6	8	10	12	14	16	6	8	10	12	14	16	6	8	10	12	14	16	6	8	10	12	14	16	6	8	10	12	14	16
4	78	58	47	39	33	29	65	49	39	32	28	24	52	39	31	26	22	19	49	36	29	24	21	18	43	32	26	22	19	16
4,5	98	74	59	49	42	37	82	61	49	41	35	31	65	49	39	33	28	25	61	46	37	31	26	23	55	41	33	27	23	20
5	119	89	71	60	51	45	99	74	60	50	43	37	79	60	48	40	34	30	74	56	45	37	32	28	66	50	40	33	28	25
5,5	142	107	85	71	61	53	119	89	71	59	51	44	95	71	57	47	41	36	89	67	53	44	38	33	79	59	47	40	34	30
6	172	129	103	86	74	64	143	107	86	71	61	54	114	86	69	57	49	43	107	80	64	54	46	40	95	71	57	48	41	36
6,5	207	155	124	103	89	77	172	129	103	86	74	65	138	103	83	69	59	52	129	97	77	65	55	48	115	86	69	57	49	43
7	241	181	145	121	103	91	201	151	121	101	86	75	161	121	97	80	69	60	151	113	91	75	65	57	134	101	80	67	57	50
7,5	292	219	175	146	125	109	243	182	146	122	104	91	194	146	117	97	83	73	182	137	109	91	78	68	162	122	97	81	69	61
8	339	255	204	170	145	127	283	212	170	141	121	106	226	170	136	113	97	85	212	159	127	106	91	80	189	141	113	94	81	71
8,5	398	298	239	199	170	149	331	248	199	166	142	124	265	199	159	133	114	99	248	186	149	124	106	93	221	166	133	110	95	83
9	452	339	271	226	194	170	377	283	226	188	162	141	302	226	181	151	129	113	283	212	170	141	121	106	251	188	151	126	108	94
9,5	519	389	311	259	222	195	432	324	259	216	185	162	346	259	208	173	148	130	324	243	195	162	139	122	288	216	173	144	124	108
10	596	447	358	298	255	223	497	372	298	248	213	186	397	298	238	199	170	149	372	279	223	186	160	140	331	248	199	166	142	124
10,5	673	505	404	336	288	252	561	421	336	280	240	210	449	336	269	224	192	168	421	315	252	210	180	158	374	280	224	187	160	140
11	743	557	446	372	318	279	619	464	372	310	265	232	495	372	297	248	212	186	464	348	279	232	199	174	413	310	248	206	177	155
11,5	836	627	502	418	358	314	697	523	418	348	299	261	558	418	335	279	239	209	523	392	314	261	224	196	465	348	279	232	199	174
12	945	709	567	472	405	354	787	590	472	394	337	295	630	472	378	315	270	236	590	443	354	295	253	221	525	394	315	262	225	197
12,5	1034	776	621	517	443	388	862	647	517	431	369	323	690	517	414	345	296	259	647	485	388	323	277	242	575	431	345	287	246	216
13	1143	858	686	572	490	429	953	715	572	476	408	357	762	572	457	381	327	286	715	536	429	357	306	268	635	476	381	318	272	238
13,5	1263	948	758	632	541	474	1053	790	632	526	451	395	842	632	505	421	361	316	790	592	474	395	338	296	702	526	421	351	301	263
14	1403	1052	842	702	601	526	1169	877	702	585	501	439	935	702	561	468	401	351	877	658	526	439	376	329	780	585	468	390	334	292
14,5	1540	1155	924	770	660	578	1284	963	770	642	550	481	1027	770	616	513	440	385	963	722	578	481	413	361	856	642	513	428	367	321
15	1682	1262	1009	841	721	631	1402	1052	841	701	601	526	1122	841	673	561	481	421	1052	789	631	526	451	394	935	701	561	467	401	351
15,5	1833	1375	1100	917	786	687	1528	1146	917	764	655	573	1222	917	733	611	524	458	1146	859	687	573	491	430	1018	764	611	509	436	382
16	2000	1500	1200	1000	857	750	1667	1250	1000	833	714	625	1333	1000	800	667	571	500	1250	938	750	625	536	469	1111	833	667	556	476	417
16,5	2137	1603	1282	1069	916	801	1781	1336	1069	891	763	668	1425	1069	855	712	611	534	1336	1002	801	668	572	501	1187	891	712	594	509	445
17	2330	1748	1398	1165	999	874	1942	1457	1165	971	832	728	1554	1165	932	777	666	583	1457	1092	874	728	624	546	1295	971	777	647	555	486
17,5	2468	1851	1481	1234	1058	925	2056	1542	1234	1028	881	771	1645	1234	987	823	705	617	1542	1157	925	771	661	578	1371	1028	823	685	588	514
18	2538	1904	1523	1269	1088	952	2115	1587	1269	1058	907	793	1692	1269	1015	846	725	635	1587	1190	952	793	680	595	1410	1058	846	705	604	529
18,5	45309	33982	27185	22655	19418	16991	37758	28318	22655	18879	16182	14159	30206	22655	18124	15103	12945	11327	28318	21239	16991	14159	12136	10619	25172	18879	15103	12586	10788	9439

LD 0 - Lopatka 0 długa
LD 1 - Lopatka 1 długa
LK 0 - Lopatka 0 krótka
LK 1 - Lopatka 1 krótka



Tabela wysiewu

SIPMA RN 610 ANTEK

Tarcza: 430

Lopatki I

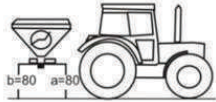

NPK 8 - 24 - 24 Polifoska 8

Grupa Azoty Zakłady Chemiczne „Police” S.A.

Formuła nawozu: NPK(S) 8-24-24-(9)
Klasa ziarnowa: granule 2-5 mm, nie mniej niż 92%
Gęstość nasypowa: 0,9-1,0 kg/dm³

Szerokość robocza	12 m						15 m						16 m						18 m					
Typ i ustawienie lopatek	LD I - 1						LD I - 1						LD I - 1,3						LD I - 2,1					
	LK I - 0,2						LK I - 0,4						LK I - 1,1						LK I - 1,4					
Obroty	540 obr/min						540 obr/min						540 obr/min						540 obr/min					
Dawka wysiewu	kg/ha																							
Nastawa	Prędk. robocza [km/h]						Prędk. robocza [km/h]						Prędk. robocza [km/h]						Prędk. robocza [km/h]					
	6	8	10	12	14	16	6	8	10	12	14	16	6	8	10	12	14	16	6	8	10	12	14	16
4	65	49	39	32	28	24	52	39	31	26	22	19	49	36	29	24	21	18	43	32	26	22	19	16
4,5	82	61	49	41	35	31	65	49	39	33	28	25	61	46	37	31	26	23	55	41	33	27	23	20
5	99	74	60	50	43	37	79	60	48	40	34	30	74	56	45	37	32	28	66	50	40	33	28	25
5,5	119	89	71	59	51	44	95	71	57	47	41	36	89	67	53	44	38	33	79	59	47	40	34	30
6	143	107	86	71	61	54	114	86	69	57	49	43	107	80	64	54	46	40	95	71	57	48	41	36
6,5	172	129	103	86	74	65	138	103	83	69	59	52	129	97	77	65	55	48	115	86	69	57	49	43
7	201	151	121	101	86	75	161	121	97	80	69	60	151	113	91	75	65	57	134	101	80	67	57	50
7,5	243	182	146	122	104	91	194	146	117	97	83	73	182	137	109	91	78	68	162	122	97	81	69	61
8	283	212	170	141	121	106	226	170	136	113	97	85	212	159	127	106	91	80	189	141	113	94	81	71
8,5	331	248	199	166	142	124	265	199	159	133	114	99	248	186	149	124	106	93	221	166	133	110	95	83
9	377	283	226	188	162	141	302	226	181	151	129	113	283	212	170	141	121	106	251	188	151	126	108	94
9,5	432	324	259	216	185	162	346	259	208	173	148	130	324	243	195	162	139	122	288	216	173	144	124	108
10	497	372	298	248	213	186	397	298	238	199	170	149	372	279	223	186	160	140	331	248	199	166	142	124
10,5	561	421	336	280	240	210	449	336	269	224	192	168	421	315	252	210	180	158	374	280	224	187	160	140
11	619	464	372	310	265	232	495	372	297	248	212	186	464	348	279	232	199	174	413	310	248	206	177	155
11,5	697	523	418	348	299	261	558	418	335	279	239	209	523	392	314	261	224	196	465	348	279	232	199	174
12	787	590	472	394	337	295	630	472	378	315	270	236	590	443	354	295	253	221	525	394	315	262	225	197
12,5	862	647	517	431	369	323	690	517	414	345	296	259	647	485	388	323	277	242	575	431	345	287	246	216
13	953	715	572	476	408	357	762	572	457	381	327	286	715	536	429	357	306	268	635	476	381	318	272	238
13,5	1053	790	632	526	451	395	842	632	505	421	361	316	790	592	474	395	338	296	702	526	421	351	301	263
14	1169	877	702	585	501	439	935	702	561	468	401	351	877	658	526	439	376	329	780	585	468	390	334	292
14,5	1284	963	770	642	550	481	1027	770	616	513	440	385	963	722	578	481	413	361	856	642	513	428	367	321
15	1402	1052	841	701	601	526	1122	841	673	561	481	421	1052	789	631	526	451	394	935	701	561	467	401	351
15,5	1528	1146	917	764	655	573	1222	917	733	611	524	458	1146	859	687	573	491	430	1018	764	611	509	436	382
16	1667	1250	1000	833	714	625	1333	1000	800	667	571	500	1250	938	750	625	536	469	1111	833	667	556	476	417
16,5	1781	1336	1069	891	763	668	1425	1069	855	712	611	534	1336	1002	801	668	572	501	1187	891	712	594	509	445
17	1942	1457	1165	971	832	728	1554	1165	932	777	666	583	1457	1092	874	728	624	546	1295	971	777	647	555	486
17,5	2056	1542	1234	1028	881	771	1645	1234	987	823	705	617	1542	1157	925	771	661	578	1371	1028	823	685	588	514
18	2115	1587	1269	1058	907	793	1692	1269	1015	846	725	635	1587	1190	952	793	680	595	1410	1058	846	705	604	529
18,5	2159	1619	1295	1079	925	810	1727	1295	1036	864	740	648	1619	1214	971	810	694	607	1439	1079	864	720	617	540

LD 0 - Lopatka 0 długa
LD I - Lopatka I długa
LK 0 - Lopatka 0 krótka
LK I - Lopatka I krótka



Tabela wysiewu

SIPMA RN 610 ANTEK

Tarcza: 430

Lopatki I



NPK 8 - 24 - 24 Polifoska 8

Grupa Azoty Zakłady Chemiczne „Police” S.A.

Formuła nawozu: NPK(S) 8-24-24-(9)
Klasa ziarnowa: granule 2-5 mm, nie mniej niż 92%
Gęstość nasypowa: 0,9-1,0 kg/dm³

Szerokość robocza	20 m						21 m						24 m					
Typ i ustawienie łopatek	LD I - 2,3						LD I - 2,3						LD I - 2,4					
	LK I - 1						LK I - 1,2						LK I - 1					
Obroty	540 obr/min						540 obr/min						540 obr/min					
Dawka wysiewu	kg/ha																	
Nastawa	Prędk. robocza [km/h]						Prędk. robocza [km/h]						Prędk. robocza [km/h]					
	6	8	10	12	14	16	6	8	10	12	14	16	6	8	10	12	14	16
4	39	29	23	19	17	15	37	28	22	19	16	14	32	24	19	16	14	12
4,5	49	37	29	25	21	18	47	35	28	23	20	18	41	31	25	20	18	15
5	60	45	36	30	26	22	57	43	34	28	24	21	50	37	30	25	21	19
5,5	71	53	43	36	31	27	68	51	41	34	29	25	59	44	36	30	25	22
6	86	64	51	43	37	32	82	61	49	41	35	31	71	54	43	36	31	27
6,5	103	77	62	52	44	39	98	74	59	49	42	37	86	65	52	43	37	32
7	121	91	72	60	52	45	115	86	69	57	49	43	101	75	60	50	43	38
7,5	146	109	87	73	62	55	139	104	83	69	60	52	122	91	73	61	52	46
8	170	127	102	85	73	64	162	121	97	81	69	61	141	106	85	71	61	53
8,5	199	149	119	99	85	75	189	142	114	95	81	71	166	124	99	83	71	62
9	226	170	136	113	97	85	215	162	129	108	92	81	188	141	113	94	81	71
9,5	259	195	156	130	111	97	247	185	148	124	106	93	216	162	130	108	93	81
10	298	223	179	149	128	112	284	213	170	142	122	106	248	186	149	124	106	93
10,5	336	252	202	168	144	126	320	240	192	160	137	120	280	210	168	140	120	105
11	372	279	223	186	159	139	354	265	212	177	152	133	310	232	186	155	133	116
11,5	418	314	251	209	179	157	398	299	239	199	171	149	348	261	209	174	149	131
12	472	354	283	236	202	177	450	337	270	225	193	169	394	295	236	197	169	148
12,5	517	388	310	259	222	194	493	369	296	246	211	185	431	323	259	216	185	162
13	572	429	343	286	245	214	545	408	327	272	233	204	476	357	286	238	204	179
13,5	632	474	379	316	271	237	602	451	361	301	258	226	526	395	316	263	226	197
14	702	526	421	351	301	263	668	501	401	334	286	251	585	439	351	292	251	219
14,5	770	578	462	385	330	289	733	550	440	367	314	275	642	481	385	321	275	241
15	841	631	505	421	361	315	801	601	481	401	343	300	701	526	421	351	300	263
15,5	917	687	550	458	393	344	873	655	524	436	374	327	764	573	458	382	327	286
16	1000	750	600	500	429	375	952	714	571	476	408	357	833	625	500	417	357	313
16,5	1069	801	641	534	458	401	1018	763	611	509	436	382	891	668	534	445	382	334
17	1165	874	699	583	499	437	1110	832	666	555	476	416	971	728	583	486	416	364
17,5	1234	925	740	617	529	463	1175	881	705	588	504	441	1028	771	617	514	441	386
18	1269	952	762	635	544	476	1209	907	725	604	518	453	1058	793	635	529	453	397
18,5	1295	971	777	648	555	486	1234	925	740	617	529	463	1079	810	648	540	463	405

LD 0 - Łopaska 0 długa
LD I - Łopaska I długa
LK 0 - Łopaska 0 krótka
LK I - Łopaska I krótka



Tabela wysiewu

SIPMA RN 610 ANTEK

Tarcza: 430

Lopatki 0



NP 18 - 46 Polidap

Grupa Azoty Zakłady Chemiczne „Police” S.A.

Formuła nawozu: NP(S) 18-46-(5)
Klasa ziarnowa: granule 2-5 mm, nie mniej niż 92%
Gęstość nasypowa: 0,9-1,0 kg/dm³

Szerokość robocza	10 m						12 m						15 m						16 m						18 m					
Typ i ustawienie lopatek	LD 0 - 2						LD 0 - 2,4						LD 0 - 3						LD 0 - 3,1						LD 0 - 3,2					
	LK 0 - 2						LK 0 - 2						LK 0 - 2,2						LK 0 - 2,3						LK 0 - 2,4					
Obroty	540 obr/min						540 obr/min						540 obr/min						540 obr/min						540 obr/min					
Dawka wysiewu	kg/ha																													
Nastawa	Prędk. robocza [km/h]						Prędk. robocza [km/h]						Prędk. robocza [km/h]						Prędk. robocza [km/h]						Prędk. robocza [km/h]					
	6	8	10	12	14	16	6	8	10	12	14	16	6	8	10	12	14	16	6	8	10	12	14	16	6	8	10	12	14	16
4	78	58	47	39	33	29	65	49	39	32	28	24	52	39	31	26	22	19	49	36	29	24	21	18	43	32	26	22	18	16
4,5	95	72	57	48	41	36	80	60	48	40	34	30	64	48	38	32	27	24	60	45	36	30	26	22	53	40	32	27	23	20
5	118	88	71	59	50	44	98	74	59	49	42	37	79	59	47	39	34	29	74	55	44	37	32	28	65	49	39	33	28	25
5,5	142	107	85	71	61	53	119	89	71	59	51	45	95	71	57	47	41	36	89	67	53	45	38	33	79	59	47	40	34	30
6	171	128	102	85	73	64	142	107	85	71	61	53	114	85	68	57	49	43	107	80	64	53	46	40	95	71	57	47	41	36
6,5	203	153	122	102	87	76	170	127	102	85	73	64	136	102	81	68	58	51	127	95	76	64	55	48	113	85	68	57	48	42
7	246	184	147	123	105	92	205	154	123	102	88	77	164	123	98	82	70	61	154	115	92	77	66	58	136	102	82	68	58	51
7,5	292	219	175	146	125	109	243	182	146	122	104	91	194	146	117	97	83	73	182	137	109	91	78	68	162	122	97	81	69	61
8	339	254	203	169	145	127	282	212	169	141	121	106	226	169	135	113	97	85	212	159	127	106	91	79	188	141	113	94	81	71
8,5	396	297	238	198	170	149	330	248	198	165	141	124	264	198	158	132	113	99	248	186	149	124	106	93	220	165	132	110	94	83
9	448	336	269	224	192	168	374	280	224	187	160	140	299	224	179	149	128	112	280	210	168	140	120	105	249	187	149	125	107	93
9,5	520	390	312	260	223	195	433	325	260	216	186	162	346	260	208	173	148	130	325	244	195	162	139	122	289	216	173	144	124	108
10	579	434	348	290	248	217	483	362	290	241	207	181	386	290	232	193	165	145	362	272	217	181	155	136	322	241	193	161	138	121
10,5	646	484	387	323	277	242	538	404	323	269	231	202	430	323	258	215	184	161	404	303	242	202	173	151	359	269	215	179	154	135
11	730	548	438	365	313	274	608	456	365	304	261	228	487	365	292	243	209	183	456	342	274	228	196	171	406	304	243	203	174	152
11,5	807	605	484	403	346	302	672	504	403	336	288	252	538	403	323	269	230	202	504	378	302	252	216	189	448	336	269	224	192	168
12	903	677	542	451	387	339	752	564	451	376	322	282	602	451	361	301	258	226	564	423	339	282	242	212	501	376	301	251	215	188
12,5	1018	764	611	509	436	382	849	637	509	424	364	318	679	509	407	339	291	255	637	477	382	318	273	239	566	424	339	283	242	212
13	1109	831	665	554	475	416	924	693	554	462	396	346	739	554	443	370	317	277	693	520	416	346	297	260	616	462	370	308	264	231
13,5	1248	936	749	624	535	468	1040	780	624	520	446	390	832	624	499	416	357	312	780	585	468	390	334	293	693	520	416	347	297	260
14	1365	1024	819	683	585	512	1138	853	683	569	488	427	910	683	546	455	390	341	853	640	512	427	366	320	759	569	455	379	325	284
14,5	1479	1109	887	739	634	554	1232	924	739	616	528	462	986	739	591	493	422	370	924	693	554	462	396	347	821	616	493	411	352	308
15	1601	1201	961	801	686	600	1334	1001	801	667	572	500	1067	801	640	534	457	400	1001	751	600	500	429	375	890	667	534	445	381	334
15,5	1750	1312	1050	875	750	656	1458	1094	875	729	625	547	1167	875	700	583	500	437	1094	820	656	547	469	410	972	729	583	486	417	365
16	1934	1451	1160	967	829	725	1612	1209	967	806	691	604	1289	967	774	645	553	484	1209	907	725	604	518	453	1074	806	645	537	460	403
16,5	2029	1522	1217	1014	869	761	1691	1268	1014	845	725	634	1353	1014	812	676	580	507	1268	951	761	634	543	476	1127	845	676	564	483	423
17	2245	1683	1347	1122	962	842	1871	1403	1122	935	802	701	1496	1122	898	748	641	561	1403	1052	842	701	601	526	1247	935	748	624	534	468
17,5	2411	1808	1446	1205	1033	904	2009	1507	1205	1004	861	753	1607	1205	964	804	689	603	1507	1130	904	753	646	565	1339	1004	804	670	574	502
18	2594	1945	1556	1297	1112	973	2162	1621	1297	1081	926	811	1729	1297	1038	865	741	648	1621	1216	973	811	695	608	1441	1081	865	721	618	540
18,5	2699	2024	1619	1350	1157	1012	2249	1687	1350	1125	964	843	1799	1350	1080	900	771	675	1687	1265	1012	843	723	633	1499	1125	900	750	643	562

LD 0 - Lopatka 0 długa
LD 1 - Lopatka I długa
LK 0 - Lopatka 0 krótka
LK 1 - Lopatka I krótka



Tabela wysiewu

SIPMA RN 610 ANTEK

Tarcza: 430

Lopatki I



NP 18 - 46 Polidap

Grupa Azoty Zakłady Chemiczne „Police” S.A.

Formuła nawozu: NP(S) 18-46-(5)
Klasa ziarnowa: granule 2-5 mm, nie mniej niż 92%
Gęstość nasypowa: 0,9-1,0 kg/dm³

Szerokość robocza	12 m						15 m						16 m						18 m					
Typ i ustawienie lopatek	LD I - 2						LD I - 2,1						LD I - 2,2						LD I - 2,4					
	LK I - 1						LK I - 1,1						LK I - 1,2						LK I - 1,4					
Obroty	540 obr/min						540 obr/min						540 obr/min						540 obr/min					
Dawka wysiewu	kg/ha																							
Nastawa	Prędk. robocza [km/h]						Prędk. robocza [km/h]						Prędk. robocza [km/h]						Prędk. robocza [km/h]					
	6	8	10	12	14	16	6	8	10	12	14	16	6	8	10	12	14	16	6	8	10	12	14	16
4	65	49	39	32	28	24	52	39	31	26	22	19	49	36	29	24	21	18	43	32	26	22	18	16
4,5	80	60	48	40	34	30	64	48	38	32	27	24	60	45	36	30	26	22	53	40	32	27	23	20
5	98	74	59	49	42	37	79	59	47	39	34	29	74	55	44	37	32	28	65	49	39	33	28	25
5,5	119	89	71	59	51	45	95	71	57	47	41	36	89	67	53	45	38	33	79	59	47	40	34	30
6	142	107	85	71	61	53	114	85	68	57	49	43	107	80	64	53	46	40	95	71	57	47	41	36
6,5	170	127	102	85	73	64	136	102	81	68	58	51	127	95	76	64	55	48	113	85	68	57	48	42
7	205	154	123	102	88	77	164	123	98	82	70	61	154	115	92	77	66	58	136	102	82	68	58	51
7,5	243	182	146	122	104	91	194	146	117	97	83	73	182	137	109	91	78	68	162	122	97	81	69	61
8	282	212	169	141	121	106	226	169	135	113	97	85	212	159	127	106	91	79	188	141	113	94	81	71
8,5	330	248	198	165	141	124	264	198	158	132	113	99	248	186	149	124	106	93	220	165	132	110	94	83
9	374	280	224	187	160	140	299	224	179	149	128	112	280	210	168	140	120	105	249	187	149	125	107	93
9,5	433	325	260	216	186	162	346	260	208	173	148	130	325	244	195	162	139	122	289	216	173	144	124	108
10	483	362	290	241	207	181	386	290	232	193	165	145	362	272	217	181	155	136	322	241	193	161	138	121
10,5	538	404	323	269	231	202	430	323	258	215	184	161	404	303	242	202	173	151	359	269	215	179	154	135
11	608	456	365	304	261	228	487	365	292	243	209	183	456	342	274	228	196	171	406	304	243	203	174	152
11,5	672	504	403	336	288	252	538	403	323	269	230	202	504	378	302	252	216	189	448	336	269	224	192	168
12	752	564	451	376	322	282	602	451	361	301	258	226	564	423	339	282	242	212	501	376	301	251	215	188
12,5	849	637	509	424	364	318	679	509	407	339	291	255	637	477	382	318	273	239	566	424	339	283	242	212
13	924	693	554	462	396	346	739	554	443	370	317	277	693	520	416	346	297	260	616	462	370	308	264	231
13,5	1040	780	624	520	446	390	832	624	499	416	357	312	780	585	468	390	334	293	693	520	416	347	297	260
14	1138	853	683	569	488	427	910	683	546	455	390	341	853	640	512	427	366	320	759	569	455	379	325	284
14,5	1232	924	739	616	528	462	986	739	591	493	422	370	924	693	554	462	396	347	821	616	493	411	352	308
15	1334	1001	801	667	572	500	1067	801	640	534	457	400	1001	751	600	500	429	375	890	667	534	445	381	334
15,5	1458	1094	875	729	625	547	1167	875	700	583	500	437	1094	820	656	547	469	410	972	729	583	486	417	365
16	1612	1209	967	806	691	604	1289	967	774	645	553	484	1209	907	725	604	518	453	1074	806	645	537	460	403
16,5	1691	1268	1014	845	725	634	1353	1014	812	676	580	507	1268	951	761	634	543	476	1127	845	676	564	483	423
17	1871	1403	1122	935	802	701	1496	1122	898	748	641	561	1403	1052	842	701	601	526	1247	935	748	624	534	468
17,5	2009	1507	1205	1004	861	753	1607	1205	964	804	689	603	1507	1130	904	753	646	565	1339	1004	804	670	574	502
18	2162	1621	1297	1081	926	811	1729	1297	1038	865	741	648	1621	1216	973	811	695	608	1441	1081	865	721	618	540
18,5	2249	1687	1350	1125	964	843	1799	1350	1080	900	771	675	1687	1265	1012	843	723	633	1499	1125	900	750	643	562

LD 0 - Lopatka 0 długa
LD I - Lopatka I długa
LK 0 - Lopatka 0 krótka
LK I - Lopatka I krótka



Tabela wysiewu

SIPMA RN 610 ANTEK

Tarcza: 430

Lopatki I



NP 18 - 46 Polidap

Grupa Azoty Zakłady Chemiczne „Police” S.A.

Formuła nawozu: NP(S) 18-46-(5)
Klasa ziarnowa: granulę 2-5 mm, nie mniej niż 92%
Gęstość nasypowa: 0,9-1,0 kg/dm³

Szerokość robocza	20 m						21 m						24 m					
Typ i ustawienie lopatek	LD I - 3						LD I - 3,1						LD I - 3,3					
	LK I - 2						LK I - 2,2						LK I - 2,2					
Obroty	540 obr/min						540 obr/min						540 obr/min					
Dawka wysiewu	kg/ha																	
Nastawa	Prędk. robocza [km/h]						Prędk. robocza [km/h]						Prędk. robocza [km/h]					
	6	8	10	12	14	16	6	8	10	12	14	16	6	8	10	12	14	16
4	39	29	23	19	17	15	37	28	22	18	16	14	32	24	19	16	14	12
4,5	48	36	29	24	20	18	45	34	27	23	19	17	40	30	24	20	17	15
5	59	44	35	29	25	22	56	42	34	28	24	21	49	37	29	25	21	18
5,5	71	53	43	36	31	27	68	51	41	34	29	25	59	45	36	30	25	22
6	85	64	51	43	37	32	81	61	49	41	35	30	71	53	43	36	30	27
6,5	102	76	61	51	44	38	97	73	58	48	42	36	85	64	51	42	36	32
7	123	92	74	61	53	46	117	88	70	58	50	44	102	77	61	51	44	38
7,5	146	109	88	73	63	55	139	104	83	69	60	52	122	91	73	61	52	46
8	169	127	102	85	73	64	161	121	97	81	69	60	141	106	85	71	60	53
8,5	198	149	119	99	85	74	189	141	113	94	81	71	165	124	99	83	71	62
9	224	168	134	112	96	84	213	160	128	107	91	80	187	140	112	93	80	70
9,5	260	195	156	130	111	97	247	186	148	124	106	93	216	162	130	108	93	81
10	290	217	174	145	124	109	276	207	165	138	118	103	241	181	145	121	103	91
10,5	323	242	194	161	138	121	307	231	184	154	132	115	269	202	161	135	115	101
11	365	274	219	183	156	137	348	261	209	174	149	130	304	228	183	152	130	114
11,5	403	302	242	202	173	151	384	288	230	192	165	144	336	252	202	168	144	126
12	451	339	271	226	193	169	430	322	258	215	184	161	376	282	226	188	161	141
12,5	509	382	306	255	218	191	485	364	291	242	208	182	424	318	255	212	182	159
13	554	416	333	277	238	208	528	396	317	264	226	198	462	346	277	231	198	173
13,5	624	468	374	312	267	234	594	446	357	297	255	223	520	390	312	260	223	195
14	683	512	410	341	293	256	650	488	390	325	279	244	569	427	341	284	244	213
14,5	739	554	444	370	317	277	704	528	422	352	302	264	616	462	370	308	264	231
15	801	600	480	400	343	300	762	572	457	381	327	286	667	500	400	334	286	250
15,5	875	656	525	437	375	328	833	625	500	417	357	312	729	547	437	365	312	273
16	967	725	580	484	414	363	921	691	553	460	395	345	806	604	484	403	345	302
16,5	1014	761	609	507	435	380	966	725	580	483	414	362	845	634	507	423	362	317
17	1122	842	673	561	481	421	1069	802	641	534	458	401	935	701	561	468	401	351
17,5	1205	904	723	603	517	452	1148	861	689	574	492	430	1004	753	603	502	430	377
18	1297	973	778	648	556	486	1235	926	741	618	529	463	1081	811	648	540	463	405
18,5	1350	1012	810	675	578	506	1285	964	771	643	551	482	1125	843	675	562	482	422

LD 0 - Lopatka 0 długa
LD I - Lopatka I długa
LK 0 - Lopatka 0 krótka
LK I - Lopatka I krótka



Tabela wysiewu

SIPMA RN 610 ANTEK

Tarcza: 430

Lopatkki 0

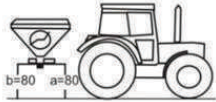

N 46 Urea Mocznik. pl

Grupa Azoty Zakłady Chemiczne „Police” S.A.

Formuła nawozu: N 46
Skład ziarnowy: granule 1-3 mm, nie mniej niż 90%
Gęstość nasypowa: 0,70 – 0,78 kg/dm³

Szerokość robocza	10 m						12 m						15 m						16 m						18 m					
Typ i ustawienie lopatek	LD 0 - 3,4						LD 0 - 3,4						LD 0 - 4						LD 0 - 4						LD 0 - 4					
	LK 0 - 2,1						LK 0 - 2,3						LK 0 - 3						LK 0 - 3,2						LK 0 - 3,2					
Obroty	540 obr/min						540 obr/min						540 obr/min						540 obr/min						600 obr/min					
Dawka wysiewu	kg/ha																													
Nastawa	Prędk. robocza [km/h]						Prędk. robocza [km/h]						Prędk. robocza [km/h]						Prędk. robocza [km/h]						Prędk. robocza [km/h]					
	6	8	10	12	14	16	6	8	10	12	14	16	6	8	10	12	14	16	6	8	10	12	14	16	6	8	10	12	14	16
4	77	58	46	39	33	29	64	48	39	32	28	24	51	39	31	26	22	19	48	36	29	24	21	18	43	32	26	21	18	16
4,5	98	73	59	49	42	37	81	61	49	41	35	31	65	49	39	33	28	24	61	46	37	31	26	23	54	41	33	27	23	20
5	121	91	73	60	52	45	101	76	60	50	43	38	81	60	48	40	35	30	76	57	45	38	32	28	67	50	40	34	29	25
5,5	148	111	89	74	64	56	124	93	74	62	53	46	99	74	59	49	42	37	93	70	56	46	40	35	82	62	49	41	35	31
6	185	139	111	93	79	70	155	116	93	77	66	58	124	93	74	62	53	46	116	87	70	58	50	43	103	77	62	52	44	39
6,5	222	166	133	111	95	83	185	138	111	92	79	69	148	111	89	74	63	55	138	104	83	69	59	52	123	92	74	62	53	46
7	264	198	159	132	113	99	220	165	132	110	94	83	176	132	106	88	76	66	165	124	99	83	71	62	147	110	88	73	63	55
7,5	320	240	192	160	137	120	266	200	160	133	114	100	213	160	128	107	91	80	200	150	120	100	86	75	178	133	107	89	76	67
8	373	280	224	186	160	140	311	233	186	155	133	117	249	186	149	124	107	93	233	175	140	117	100	87	207	155	124	104	89	78
8,5	433	325	260	217	186	162	361	271	217	180	155	135	289	217	173	144	124	108	271	203	162	135	116	102	241	180	144	120	103	90
9	487	365	292	244	209	183	406	305	244	203	174	152	325	244	195	162	139	122	305	228	183	152	131	114	271	203	162	135	116	102
9,5	554	415	332	277	237	208	461	346	277	231	198	173	369	277	221	185	158	138	346	260	208	173	148	130	308	231	185	154	132	115
10	637	478	382	319	273	239	531	398	319	266	228	199	425	319	255	212	182	159	398	299	239	199	171	149	354	266	212	177	152	133
10,5	704	528	423	352	302	264	587	440	352	294	252	220	470	352	282	235	201	176	440	330	264	220	189	165	391	294	235	196	168	147
11	785	589	471	392	336	294	654	491	392	327	280	245	523	392	314	262	224	196	491	368	294	245	210	184	436	327	262	218	187	164
11,5	864	648	518	432	370	324	720	540	432	360	309	270	576	432	346	288	247	216	540	405	324	270	231	202	480	360	288	240	206	180
12	961	721	577	481	412	361	801	601	481	401	343	300	641	481	385	320	275	240	601	451	361	300	258	225	534	401	320	267	229	200
12,5	1051	788	631	526	451	394	876	657	526	438	375	329	701	526	420	350	300	263	657	493	394	329	282	246	584	438	350	292	250	219
13	1147	860	688	573	491	430	955	717	573	478	409	358	764	573	459	382	328	287	717	537	430	358	307	269	637	478	382	318	273	239
13,5	1269	951	761	634	544	476	1057	793	634	529	453	396	846	634	507	423	362	317	793	595	476	396	340	297	705	529	423	352	302	264
14	1378	1033	827	689	590	517	1148	861	689	574	492	431	918	689	551	459	394	344	861	646	517	431	369	323	765	574	459	383	328	287
14,5	1494	1120	896	747	640	560	1245	934	747	622	534	467	996	747	598	498	427	373	934	700	560	467	400	350	830	622	498	415	356	311
15	1594	1195	956	797	683	598	1328	996	797	664	569	498	1062	797	637	531	455	398	996	747	598	498	427	374	885	664	531	443	379	332
15,5	1723	1292	1034	861	738	646	1436	1077	861	718	615	538	1149	861	689	574	492	431	1077	808	646	538	461	404	957	718	574	479	410	359
16	1865	1399	1119	933	799	699	1554	1166	933	777	666	583	1243	933	746	622	533	466	1166	874	699	583	500	437	1036	777	622	518	444	389
16,5	1992	1494	1195	996	854	747	1660	1245	996	830	712	623	1328	996	797	664	569	498	1245	934	747	623	534	467	1107	830	664	553	474	415
17	2152	1614	1291	1076	922	807	1794	1345	1076	897	769	673	1435	1076	861	717	615	538	1345	1009	807	673	576	504	1196	897	717	598	512	448
17,5	2275	1706	1365	1138	975	853	1896	1422	1138	948	813	711	1517	1138	910	758	650	569	1422	1067	853	711	609	533	1264	948	758	632	542	474
18	2326	1744	1396	1163	997	872	1938	1454	1163	969	831	727	1551	1163	930	775	665	581	1454	1090	872	727	623	545	1292	969	775	646	554	485
18,5	2385	1789	1431	1192	1022	894	1987	1491	1192	994	852	745	1590	1192	954	795	681	596	1491	1118	894	745	639	559	1325	994	795	662	568	497

LD 0 - Lopatka 0 długa
LD 1 - Lopatka I długa
LK 0 - Lopatka 0 krótka
LK 1 - Lopatka I krótka



Tabela wysiewu

SIPMA RN 610 ANTEK

Tarcza: 430

Lopatki I



N 46 Urea Mocznik. pl

Grupa Azoty Zakłady Chemiczne „Police” S.A.

Formuła nawozu: N 46
Skład ziarnowy: granule 1-3 mm, nie mniej niż 90%
Gęstość nasypowa: 0,70 – 0,78 kg/dm³

Szerokość robocza	12 m						15 m						16 m					
Typ i ustawienie łopatek	LD I - 2,4						LD I - 3						LD I - 3,2					
	LK I - 1,4						LK I - 1,4						LK I - 2,1					
Obroty	540 obr/min						540 obr/min						540 obr/min					
Dawka wysiewu	kg/ha																	
Nastawa	Prędk. robocza [km/h]						Prędk. robocza [km/h]						Prędk. robocza [km/h]					
	6	8	10	12	14	16	6	8	10	12	14	16	6	8	10	12	14	16
4	64	48	39	32	28	24	51	39	31	26	22	19	48	36	29	24	21	18
4,5	81	61	49	41	35	31	65	49	39	33	28	24	61	46	37	31	26	23
5	101	76	60	50	43	38	81	60	48	40	35	30	76	57	45	38	32	28
5,5	124	93	74	62	53	46	99	74	59	49	42	37	93	70	56	46	40	35
6	155	116	93	77	66	58	124	93	74	62	53	46	116	87	70	58	50	43
6,5	185	138	111	92	79	69	148	111	89	74	63	55	138	104	83	69	59	52
7	220	165	132	110	94	83	176	132	106	88	76	66	165	124	99	83	71	62
7,5	266	200	160	133	114	100	213	160	128	107	91	80	200	150	120	100	86	75
8	311	233	186	155	133	117	249	186	149	124	107	93	233	175	140	117	100	87
8,5	361	271	217	180	155	135	289	217	173	144	124	108	271	203	162	135	116	102
9	406	305	244	203	174	152	325	244	195	162	139	122	305	228	183	152	131	114
9,5	461	346	277	231	198	173	369	277	221	185	158	138	346	260	208	173	148	130
10	531	398	319	266	228	199	425	319	255	212	182	159	398	299	239	199	171	149
10,5	587	440	352	294	252	220	470	352	282	235	201	176	440	330	264	220	189	165
11	654	491	392	327	280	245	523	392	314	262	224	196	491	368	294	245	210	184
11,5	720	540	432	360	309	270	576	432	346	288	247	216	540	405	324	270	231	202
12	801	601	481	401	343	300	641	481	385	320	275	240	601	451	361	300	258	225
12,5	876	657	526	438	375	329	701	526	420	350	300	263	657	493	394	329	282	246
13	955	717	573	478	409	358	764	573	459	382	328	287	717	537	430	358	307	269
13,5	1057	793	634	529	453	396	846	634	507	423	362	317	793	595	476	396	340	297
14	1148	861	689	574	492	431	918	689	551	459	394	344	861	646	517	431	369	323
14,5	1245	934	747	622	534	467	996	747	598	498	427	373	934	700	560	467	400	350
15	1328	996	797	664	569	498	1062	797	637	531	455	398	996	747	598	498	427	374
15,5	1436	1077	861	718	615	538	1149	861	689	574	492	431	1077	808	646	538	461	404
16	1554	1166	933	777	666	583	1243	933	746	622	533	466	1166	874	699	583	500	437
16,5	1660	1245	996	830	712	623	1328	996	797	664	569	498	1245	934	747	623	534	467
17	1794	1345	1076	897	769	673	1435	1076	861	717	615	538	1345	1009	807	673	576	504
17,5	1896	1422	1138	948	813	711	1517	1138	910	758	650	569	1422	1067	853	711	609	533
18	1938	1454	1163	969	831	727	1551	1163	930	775	665	581	1454	1090	872	727	623	545
18,5	1987	1491	1192	994	852	745	1590	1192	954	795	681	596	1491	1118	894	745	639	559

LD I - Łopatka I długa
LD II - Łopatka II długa
LK I - Łopatka I krótka
LK II - Łopatka II krótka



Tabela wysiewu

SIPMA RN 610 ANTEK

Tarcza: 430

Łopatki I



N 46 Urea Mocznik. pl

Grupa Azoty Zakłady Chemiczne „Police” S.A.

Formuła nawozu: N 46
Skład ziarnowy: granule 1-3 mm, nie mniej niż 90%
Gęstość nasypowa: 0,70 – 0,78 kg/dm³

Szerokość robocza	18 m						20 m						21 m					
Typ i ustawienie łopatek	LD I - 3,4						LD I - 4						LD I - 4					
	LK I - 2,2						LK I - 2,2						LK I - 2,2					
Obroty	540 obr/min						540 obr/min						600 obr/min					
Dawka wysiewu	kg/ha																	
Nastawa	Prędk. robocza [km/h]						Prędk. robocza [km/h]						Prędk. robocza [km/h]					
	6	8	10	12	14	16	6	8	10	12	14	16	6	8	10	12	14	16
4	43	32	26	21	18	16	39	29	23	19	17	14	37	28	22	18	16	14
4,5	54	41	33	27	23	20	49	37	29	24	21	18	46	35	28	23	20	17
5	67	50	40	34	29	25	60	45	36	30	26	23	58	43	35	29	25	22
5,5	82	62	49	41	35	31	74	56	45	37	32	28	71	53	42	35	30	27
6	103	77	62	52	44	39	93	70	56	46	40	35	88	66	53	44	38	33
6,5	123	92	74	62	53	46	111	83	66	55	47	42	105	79	63	53	45	40
7	147	110	88	73	63	55	132	99	79	66	57	50	126	94	76	63	54	47
7,5	178	133	107	89	76	67	160	120	96	80	68	60	152	114	91	76	65	57
8	207	155	124	104	89	78	186	140	112	93	80	70	178	133	107	89	76	67
8,5	241	180	144	120	103	90	217	162	130	108	93	81	206	155	124	103	88	77
9	271	203	162	135	116	102	244	183	146	122	104	91	232	174	139	116	99	87
9,5	308	231	185	154	132	115	277	208	166	138	119	104	264	198	158	132	113	99
10	354	266	212	177	152	133	319	239	191	159	137	120	304	228	182	152	130	114
10,5	391	294	235	196	168	147	352	264	211	176	151	132	335	252	201	168	144	126
11	436	327	262	218	187	164	392	294	235	196	168	147	374	280	224	187	160	140
11,5	480	360	288	240	206	180	432	324	259	216	185	162	411	309	247	206	176	154
12	534	401	320	267	229	200	481	361	288	240	206	180	458	343	275	229	196	172
12,5	584	438	350	292	250	219	526	394	315	263	225	197	501	375	300	250	215	188
13	637	478	382	318	273	239	573	430	344	287	246	215	546	409	328	273	234	205
13,5	705	529	423	352	302	264	634	476	381	317	272	238	604	453	362	302	259	227
14	765	574	459	383	328	287	689	517	413	344	295	258	656	492	394	328	281	246
14,5	830	622	498	415	356	311	747	560	448	373	320	280	711	534	427	356	305	267
15	885	664	531	443	379	332	797	598	478	398	342	299	759	569	455	379	325	285
15,5	957	718	574	479	410	359	861	646	517	431	369	323	820	615	492	410	352	308
16	1036	777	622	518	444	389	933	699	560	466	400	350	888	666	533	444	381	333
16,5	1107	830	664	553	474	415	996	747	598	498	427	374	949	712	569	474	407	356
17	1196	897	717	598	512	448	1076	807	646	538	461	404	1025	769	615	512	439	384
17,5	1264	948	758	632	542	474	1138	853	683	569	488	427	1083	813	650	542	464	406
18	1292	969	775	646	554	485	1163	872	698	581	498	436	1108	831	665	554	475	415
18,5	1325	994	795	662	568	497	1192	894	715	596	511	447	1136	852	681	568	487	426

LD I - Łopatka I długa
LD II - Łopatka II długa
LK I - Łopatka I krótka
LK II - Łopatka II krótka



Tabela wysiewu

SIPMA RN 610 ANTEK

Tarcza: 430

Lopatkı 0



N 27 CAN Saletrzak 27

Grupa Azoty Zaklady Azotowe Tarnów S.A.

Formuła nawozu: N(CaO, MgO) 27(2,4)
 Klasa ziarnowa: granule 2,0-6,0 mm, co najmniej 95%
 Gęstość nasypowa: 1,0 kg/dm3

Szerokość robocza	10 m						12 m						15 m						16 m						18 m					
Typ i ustawienie lopatek	LD 0 - 3						LD 0 - 3						LD 0 - 3,4						LD 0 - 3,4						LD 0 - 4					
	LK 0 - 1,4						LK 0 - 2,1						LK 0 - 2						LK 0 - 2,2						LK 0 - 2,2					
Obroty	540 obr/min						540 obr/min						540 obr/min						540 obr/min						540 obr/min					
Dawka wysiewu	kg/ha																													
Nastawa	Prędk. robocza [km/h]						Prędk. robocza [km/h]						Prędk. robocza [km/h]						Prędk. robocza [km/h]						Prędk. robocza [km/h]					
	6	8	10	12	14	16	6	8	10	12	14	16	6	8	10	12	14	16	6	8	10	12	14	16	6	8	10	12	14	16
4	108	81	65	54	46	40	90	67	54	45	38	34	72	54	43	36	31	27	67	50	40	34	29	25	60	45	36	30	26	22
4,5	127	96	76	64	55	48	106	80	64	53	46	40	85	64	51	42	36	32	80	60	48	40	34	30	71	53	42	35	30	27
5	167	125	100	83	71	63	139	104	83	69	60	52	111	83	67	56	48	42	104	78	63	52	45	39	93	69	56	46	40	35
5,5	200	150	120	100	86	75	167	125	100	83	72	63	134	100	80	67	57	50	125	94	75	63	54	47	111	83	67	56	48	42
6	238	178	143	119	102	89	198	149	119	99	85	74	159	119	95	79	68	59	149	112	89	74	64	56	132	99	79	66	57	50
6,5	282	212	169	141	121	106	235	177	141	118	101	88	188	141	113	94	81	71	177	132	106	88	76	66	157	118	94	78	67	59
7	336	252	202	168	144	126	280	210	168	140	120	105	224	168	134	112	96	84	210	158	126	105	90	79	187	140	112	93	80	70
7,5	419	314	251	210	180	157	349	262	210	175	150	131	279	210	168	140	120	105	262	196	157	131	112	98	233	175	140	116	100	87
8	477	358	286	238	204	179	397	298	238	199	170	149	318	238	191	159	136	119	298	223	179	149	128	112	265	199	159	132	114	99
8,5	546	409	327	273	234	205	455	341	273	227	195	170	364	273	218	182	156	136	341	256	205	170	146	128	303	227	182	152	130	114
9	615	461	369	308	264	231	513	384	308	256	220	192	410	308	246	205	176	154	384	288	231	192	165	144	342	256	205	171	146	128
9,5	705	528	423	352	302	264	587	440	352	294	252	220	470	352	282	235	201	176	440	330	264	220	189	165	391	294	235	196	168	147
10	786	590	472	393	337	295	655	492	393	328	281	246	524	393	315	262	225	197	492	369	295	246	211	184	437	328	262	218	187	164
10,5	896	672	537	448	384	336	746	560	448	373	320	280	597	448	358	299	256	224	560	420	336	280	240	210	498	373	299	249	213	187
11	993	745	596	497	426	373	828	621	497	414	355	310	662	497	397	331	284	248	621	466	373	310	266	233	552	414	331	276	237	207
11,5	1097	823	658	548	470	411	914	686	548	457	392	343	731	548	439	366	313	274	686	514	411	343	294	257	609	457	366	305	261	229
12	1212	909	727	606	519	455	1010	758	606	505	433	379	808	606	485	404	346	303	758	568	455	379	325	284	673	505	404	337	289	253
12,5	1322	992	793	661	567	496	1102	826	661	551	472	413	881	661	529	441	378	331	826	620	496	413	354	310	734	551	441	367	315	275
13	1460	1095	876	730	626	547	1216	912	730	608	521	456	973	730	584	487	417	365	912	684	547	456	391	342	811	608	487	405	348	304
13,5	1614	1210	968	807	692	605	1345	1009	807	672	576	504	1076	807	646	538	461	403	1009	756	605	504	432	378	897	672	538	448	384	336
14	1727	1295	1036	863	740	647	1439	1079	863	719	617	540	1151	863	691	576	493	432	1079	809	647	540	462	405	959	719	576	480	411	360
14,5	1859	1395	1116	930	797	697	1550	1162	930	775	664	581	1240	930	744	620	531	465	1162	872	697	581	498	436	1033	775	620	517	443	387
15	2077	1557	1246	1038	890	779	1730	1298	1038	865	742	649	1384	1038	831	692	593	519	1298	973	779	649	556	487	1154	865	692	577	494	433
15,5	2233	1674	1340	1116	957	837	1861	1395	1116	930	797	698	1488	1116	893	744	638	558	1395	1047	837	698	598	523	1240	930	744	620	532	465
16	2358	1769	1415	1179	1011	884	1965	1474	1179	983	842	737	1572	1179	943	786	674	590	1474	1105	884	737	632	553	1310	983	786	655	561	491
16,5	2589	1941	1553	1294	1109	971	2157	1618	1294	1079	925	809	1726	1294	1035	863	740	647	1618	1213	971	809	693	607	1438	1079	863	719	616	539
17	2759	2069	1655	1379	1182	1035	2299	1724	1379	1150	985	862	1839	1379	1104	920	788	690	1724	1293	1035	862	739	647	1533	1150	920	766	657	575
17,5	2960	2220	1776	1480	1269	1110	2467	1850	1480	1233	1057	925	1973	1480	1184	987	846	740	1850	1388	1110	925	793	694	1645	1233	987	822	705	617
18	3111	2333	1866	1555	1333	1167	2592	1944	1555	1296	1111	972	2074	1555	1244	1037	889	778	1944	1458	1167	972	833	729	1728	1296	1037	864	741	648
18,5	3216	2412	1930	1608	1378	1206	2680	2010	1608	1340	1149	1005	2144	1608	1286	1072	919	804	2010	1508	1206	1005	861	754	1787	1340	1072	893	766	670

LD 0 - Lopatka 0 długa
 LD 1 - Lopatka I długa
 LK 0 - Lopatka 0 krótka
 LK 1 - Lopatka I krótka



Tabela wysiewu

SIPMA RN 610 ANTEK

Tarcza: 430

Lopatki I



N 27 CAN Saletrzak 27 standard

Grupa Azoty Zakłady Azotowe Tarnów S.A.

Formuła nawozu: N(CaO, MgO) 27(2,4)
 Klasa ziarnowa: granule 2,0-6,0 mm, co najmniej 95%
 Gęstość nasypowa: 1,0 kg/dm³

Szerokość robocza	12 m						15 m						16 m						18 m					
Typ i ustawienie lopatek	LD I - 1,4						LD I - 2						LD I - 2,3						LD I - 3					
	LK I - 1,2						LK I - 1,2						LK I - 1,2						LK I - 1,2					
Obroty	540 obr/min						540 obr/min						540 obr/min						540 obr/min					
Dawka wysiewu	kg/ha																							
Nastawa	Prędk. robocza [km/h]						Prędk. robocza [km/h]						Prędk. robocza [km/h]						Prędk. robocza [km/h]					
	6	8	10	12	14	16	6	8	10	12	14	16	6	8	10	12	14	16	6	8	10	12	14	16
4	90	67	54	45	38	34	72	54	43	36	31	27	67	50	40	34	29	25	60	45	36	30	26	22
4,5	106	80	64	53	46	40	85	64	51	42	36	32	80	60	48	40	34	30	71	53	42	35	30	27
5	139	104	83	69	60	52	111	83	67	56	48	42	104	78	63	52	45	39	93	69	56	46	40	35
5,5	167	125	100	83	72	63	134	100	80	67	57	50	125	94	75	63	54	47	111	83	67	56	48	42
6	198	149	119	99	85	74	159	119	95	79	68	59	149	112	89	74	64	56	132	99	79	66	57	50
6,5	235	177	141	118	101	88	188	141	113	94	81	71	177	132	106	88	76	66	157	118	94	78	67	59
7	280	210	168	140	120	105	224	168	134	112	96	84	210	158	126	105	90	79	187	140	112	93	80	70
7,5	349	262	210	175	150	131	279	210	168	140	120	105	262	196	157	131	112	98	233	175	140	116	100	87
8	397	298	238	199	170	149	318	238	191	159	136	119	298	223	179	149	128	112	265	199	159	132	114	99
8,5	455	341	273	227	195	170	364	273	218	182	156	136	341	256	205	170	146	128	303	227	182	152	130	114
9	513	384	308	256	220	192	410	308	246	205	176	154	384	288	231	192	165	144	342	256	205	171	146	128
9,5	587	440	352	294	252	220	470	352	282	235	201	176	440	330	264	220	189	165	391	294	235	196	168	147
10	655	492	393	328	281	246	524	393	315	262	225	197	492	369	295	246	211	184	437	328	262	218	187	164
10,5	746	560	448	373	320	280	597	448	358	299	256	224	560	420	336	280	240	210	498	373	299	249	213	187
11	828	621	497	414	355	310	662	497	397	331	284	248	621	466	373	310	266	233	552	414	331	276	237	207
11,5	914	686	548	457	392	343	731	548	439	366	313	274	686	514	411	343	294	257	609	457	366	305	261	229
12	1010	758	606	505	433	379	808	606	485	404	346	303	758	568	455	379	325	284	673	505	404	337	289	253
12,5	1102	826	661	551	472	413	881	661	529	441	378	331	826	620	496	413	354	310	734	551	441	367	315	275
13	1216	912	730	608	521	456	973	730	584	487	417	365	912	684	547	456	391	342	811	608	487	405	348	304
13,5	1345	1009	807	672	576	504	1076	807	646	538	461	403	1009	756	605	504	432	378	897	672	538	448	384	336
14	1439	1079	863	719	617	540	1151	863	691	576	493	432	1079	809	647	540	462	405	959	719	576	480	411	360
14,5	1550	1162	930	775	664	581	1240	930	744	620	531	465	1162	872	697	581	498	436	1033	775	620	517	443	387
15	1730	1298	1038	865	742	649	1384	1038	831	692	593	519	1298	973	779	649	556	487	1154	865	692	577	494	433
15,5	1861	1395	1116	930	797	698	1488	1116	893	744	638	558	1395	1047	837	698	598	523	1240	930	744	620	532	465
16	1965	1474	1179	983	842	737	1572	1179	943	786	674	590	1474	1105	884	737	632	553	1310	983	786	655	561	491
16,5	2157	1618	1294	1079	925	809	1726	1294	1035	863	740	647	1618	1213	971	809	693	607	1438	1079	863	719	616	539
17	2299	1724	1379	1150	985	862	1839	1379	1104	920	788	690	1724	1293	1035	862	739	647	1533	1150	920	766	657	575
17,5	2467	1850	1480	1233	1057	925	1973	1480	1184	987	846	740	1850	1388	1110	925	793	694	1645	1233	987	822	705	617
18	2592	1944	1555	1296	1111	972	2074	1555	1244	1037	889	778	1944	1458	1167	972	833	729	1728	1296	1037	864	741	648
18,5	2680	2010	1608	1340	1149	1005	2144	1608	1286	1072	919	804	2010	1508	1206	1005	861	754	1787	1340	1072	893	766	670

LD 0 - Lopatka 0 długa
 LD I - Lopatka I długa
 LK 0 - Lopatka 0 krótka
 LK I - Lopatka I krótka



Tabela wysiewu

SIPMA RN 610 ANTEK

Tarcza: 430

Lopatki I



N 27 CAN Saletrzak 27 standard

Grupa Azoty Zakłady Azotowe Tarnów S.A.

Formuła nawozu: N(CaO, MgO) 27(2,4)
Klasa ziarnowa: granule 2,0-6,0 mm, co najmniej 95%
Gęstość nasypowa: 1,0 kg/dm³

Szerokość robocza	20 m						21 m						24 m					
Typ i ustawienie lopatek	LD I - 3,2						LD I - 3,4						LD I - 4					
	LK I - 1,2						LK I - 1,2						LK I - 1,4					
Obroty	540 obr/min						540 obr/min						540 obr/min					
Dawka wysiewu	kg/ha																	
Nastawa	Prędk. robocza [km/h]						Prędk. robocza [km/h]						Prędk. robocza [km/h]					
	6	8	10	12	14	16	6	8	10	12	14	16	6	8	10	12	14	16
4	54	40	32	27	23	20	51	38	31	26	22	19	45	34	27	22	19	17
4,5	64	48	38	32	27	24	61	46	36	30	26	23	53	40	32	27	23	20
5	83	63	50	42	36	31	79	60	48	40	34	30	69	52	42	35	30	26
5,5	100	75	60	50	43	38	95	72	57	48	41	36	83	63	50	42	36	31
6	119	89	71	59	51	45	113	85	68	57	49	42	99	74	59	50	42	37
6,5	141	106	85	71	61	53	135	101	81	67	58	50	118	88	71	59	50	44
7	168	126	101	84	72	63	160	120	96	80	69	60	140	105	84	70	60	53
7,5	210	157	126	105	90	79	200	150	120	100	86	75	175	131	105	87	75	65
8	238	179	143	119	102	89	227	170	136	114	97	85	199	149	119	99	85	74
8,5	273	205	164	136	117	102	260	195	156	130	111	97	227	170	136	114	97	85
9	308	231	185	154	132	115	293	220	176	146	126	110	256	192	154	128	110	96
9,5	352	264	211	176	151	132	335	252	201	168	144	126	294	220	176	147	126	110
10	393	295	236	197	169	147	374	281	225	187	160	140	328	246	197	164	140	123
10,5	448	336	269	224	192	168	427	320	256	213	183	160	373	280	224	187	160	140
11	497	373	298	248	213	186	473	355	284	237	203	177	414	310	248	207	177	155
11,5	548	411	329	274	235	206	522	392	313	261	224	196	457	343	274	229	196	171
12	606	455	364	303	260	227	577	433	346	289	247	216	505	379	303	253	216	189
12,5	661	496	397	331	283	248	630	472	378	315	270	236	551	413	331	275	236	207
13	730	547	438	365	313	274	695	521	417	348	298	261	608	456	365	304	261	228
13,5	807	605	484	403	346	303	768	576	461	384	329	288	672	504	403	336	288	252
14	863	647	518	432	370	324	822	617	493	411	352	308	719	540	432	360	308	270
14,5	930	697	558	465	398	349	885	664	531	443	379	332	775	581	465	387	332	291
15	1038	779	623	519	445	389	989	742	593	494	424	371	865	649	519	433	371	324
15,5	1116	837	670	558	478	419	1063	797	638	532	456	399	930	698	558	465	399	349
16	1179	884	707	590	505	442	1123	842	674	561	481	421	983	737	590	491	421	368
16,5	1294	971	777	647	555	485	1233	925	740	616	528	462	1079	809	647	539	462	404
17	1379	1035	828	690	591	517	1314	985	788	657	563	493	1150	862	690	575	493	431
17,5	1480	1110	888	740	634	555	1410	1057	846	705	604	529	1233	925	740	617	529	463
18	1555	1167	933	778	667	583	1481	1111	889	741	635	555	1296	972	778	648	555	486
18,5	1608	1206	965	804	689	603	1531	1149	919	766	656	574	1340	1005	804	670	574	503

LD 0 - Lopatka 0 długa
LD 1 - Lopatka I długa
LK 0 - Lopatka 0 krótka
LK 1 - Lopatka I krótka



Tabela wysiewu

SIPMA RN 610 ANTEK

Tarcza: 430

Lopatki 0



NS 26 - 13 Saletrosan 26

Grupa Azoty Zakłady Azotowe Tarnów S.A.

Formuła nawozu: N(S) 26-(13)
Klasa ziarnowa: granule 2-6 mm, nie mniej niż 95%
Gęstość nasypowa: 0,98 kg/dm³

Szerokość robocza	10 m						12 m						15 m						15 m						18 m					
Typ i ustawienie lopatek	LD 0 - 2,5						LD 0 - 2,5						LD 0 - 3						LD 0 - 3,1						LD 0 - 3,2					
	LK 0 - 2						LK 0 - 2,2						LK 0 - 2						LK 0 - 2						LK 0 - 2,1					
Obroty	540 obr/min						540 obr/min						540 obr/min						540 obr/min						540 obr/min					
Dawka wysiewu	kg/ha																													
Nastawa	Prędk. robocza [km/h]						Prędk. robocza [km/h]						Prędk. robocza [km/h]						Prędk. robocza [km/h]						Prędk. robocza [km/h]					
	6	8	10	12	14	16	6	8	10	12	14	16	6	8	10	12	14	16	6	8	10	12	14	16	6	8	10	12	14	16
4	55	41	33	28	24	21	46	35	28	23	20	17	37	28	22	18	16	14	37	28	22	18	16	14	31	23	18	15	13	12
4,5	70	52	42	35	30	26	58	44	35	29	25	22	47	35	28	23	20	17	47	35	28	23	20	17	39	29	23	19	17	15
5	85	63	51	42	36	32	70	53	42	35	30	26	56	42	34	28	24	21	56	42	34	28	24	21	47	35	28	23	20	18
5,5	105	79	63	52	45	39	87	66	52	44	37	33	70	52	42	35	30	26	70	52	42	35	30	26	58	44	35	29	25	22
6	125	93	75	62	53	47	104	78	62	52	44	39	83	62	50	42	36	31	83	62	50	42	36	31	69	52	42	35	30	26
6,5	146	109	87	73	62	55	121	91	73	61	52	46	97	73	58	49	42	36	97	73	58	49	42	36	81	61	49	40	35	30
7	178	133	107	89	76	67	148	111	89	74	64	56	119	89	71	59	51	44	119	89	71	59	51	44	99	74	59	49	42	37
7,5	209	157	126	105	90	79	175	131	105	87	75	65	140	105	84	70	60	52	140	105	84	70	60	52	116	87	70	58	50	44
8	240	180	144	120	103	90	200	150	120	100	86	75	160	120	96	80	68	60	160	120	96	80	68	60	133	100	80	67	57	50
8,5	288	216	173	144	124	108	240	180	144	120	103	90	192	144	115	96	82	72	192	144	115	96	82	72	160	120	96	80	69	60
9	331	248	198	165	142	124	276	207	165	138	118	103	220	165	132	110	94	83	220	165	132	110	94	83	184	138	110	92	79	69
9,5	379	285	228	190	163	142	316	237	190	158	135	119	253	190	152	126	108	95	253	190	152	126	108	95	211	158	126	105	90	79
10	435	326	261	217	186	163	362	272	217	181	155	136	290	217	174	145	124	109	290	217	174	145	124	109	242	181	145	121	104	91
10,5	491	369	295	246	211	184	409	307	246	205	175	154	328	246	197	164	140	123	328	246	197	164	140	123	273	205	164	136	117	102
11	561	421	337	281	240	210	468	351	281	234	200	175	374	281	224	187	160	140	374	281	224	187	160	140	312	234	187	156	134	117
11,5	599	449	359	299	257	225	499	374	299	250	214	187	399	299	240	200	171	150	399	299	240	200	171	150	333	250	200	166	143	125
12	699	524	419	350	300	262	583	437	350	291	250	218	466	350	280	233	200	175	466	350	280	233	200	175	388	291	233	194	166	146
12,5	785	588	471	392	336	294	654	490	392	327	280	245	523	392	314	262	224	196	523	392	314	262	224	196	436	327	262	218	187	163
13	883	663	530	442	379	331	736	552	442	368	316	276	589	442	353	294	252	221	589	442	353	294	252	221	491	368	294	245	210	184
13,5	971	728	582	485	416	364	809	607	485	405	347	303	647	485	388	324	277	243	647	485	388	324	277	243	539	405	324	270	231	202
14	1078	808	647	539	462	404	898	674	539	449	385	337	718	539	431	359	308	269	718	539	431	359	308	269	599	449	359	299	257	225
14,5	1185	889	711	593	508	445	988	741	593	494	423	370	790	593	474	395	339	296	790	593	474	395	339	296	659	494	395	329	282	247
15	1290	968	774	645	553	484	1075	807	645	538	461	403	860	645	516	430	369	323	860	645	516	430	369	323	717	538	430	358	307	269
15,5	1411	1059	847	706	605	529	1176	882	706	588	504	441	941	706	565	470	403	353	941	706	565	470	403	353	784	588	470	392	336	294
16	1514	1136	909	757	649	568	1262	946	757	631	541	473	1009	757	606	505	433	379	1009	757	606	505	433	379	841	631	505	421	361	315
16,5	1641	1231	985	821	703	615	1368	1026	821	684	586	513	1094	821	656	547	469	410	1094	821	656	547	469	410	912	684	547	456	391	342
17	1815	1362	1089	908	778	681	1513	1135	908	756	648	567	1210	908	726	605	519	454	1210	908	726	605	519	454	1009	756	605	504	432	378
17,5	1906	1430	1144	953	817	715	1589	1192	953	794	681	596	1271	953	763	635	545	477	1271	953	763	635	545	477	1059	794	635	530	454	397
18	1940	1455	1164	970	832	728	1617	1213	970	808	693	606	1293	970	776	647	554	485	1293	970	776	647	554	485	1078	808	647	539	462	404
18,5	1987	1490	1192	994	852	745	1656	1242	994	828	710	621	1325	994	795	662	568	497	1325	994	795	662	568	497	1104	828	662	552	473	414

LD 0 - Lopatka 0 długa
LD 1 - Lopatka I długa
LK 0 - Lopatka 0 krótka
LK 1 - Lopatka I krótka



Tabela wysiewu

SIPMA RN 610 ANTEK

Tarcza: 430

Lopatki I



NS 26 - 13 Saletrosan 26

Grupa Azoty Zakłady Azotowe Tarnów S.A.

Formuła nawozu: N(S) 26-(13)
Klasa ziarnowa: granule 2-6 mm, nie mniej niż 95%
Gęstość nasypowa: 0,98 kg/dm³

Szerokość robocza	12 m						15 m						16 m						18 m					
Typ i ustawienie lopatek	LD I - 1,4						LD I - 1,5						LD I - 2						LD I - 2,3					
	LK I - 1						LK I - 1						LK I - 1,2						LK I - 1,2					
Obroty	540 obr/min						540 obr/min						540 obr/min						540 obr/min					
Dawka wysiewu	kg/ha																							
Nastawa	Prędk. robocza [km/h]						Prędk. robocza [km/h]						Prędk. robocza [km/h]						Prędk. robocza [km/h]					
	6	8	10	12	14	16	6	8	10	12	14	16	6	8	10	12	14	16	6	8	10	12	14	16
4	46	35	28	23	20	17	37	28	22	18	16	14	35	26	21	17	15	13	31	23	18	15	13	12
4,5	58	44	35	29	25	22	47	35	28	23	20	17	44	33	26	22	19	16	39	29	23	19	17	15
5	70	53	42	35	30	26	56	42	34	28	24	21	53	40	32	26	23	20	47	35	28	23	20	18
5,5	87	66	52	44	37	33	70	52	42	35	30	26	66	49	39	33	28	25	58	44	35	29	25	22
6	104	78	62	52	44	39	83	62	50	42	36	31	78	58	47	39	33	29	69	52	42	35	30	26
6,5	121	91	73	61	52	46	97	73	58	49	42	36	91	68	55	46	39	34	81	61	49	40	35	30
7	148	111	89	74	64	56	119	89	71	59	51	44	111	83	67	56	48	42	99	74	59	49	42	37
7,5	175	131	105	87	75	65	140	105	84	70	60	52	131	98	79	65	56	49	116	87	70	58	50	44
8	200	150	120	100	86	75	160	120	96	80	68	60	150	112	90	75	64	56	133	100	80	67	57	50
8,5	240	180	144	120	103	90	192	144	115	96	82	72	180	135	108	90	77	68	160	120	96	80	69	60
9	276	207	165	138	118	103	220	165	132	110	94	83	207	155	124	103	89	77	184	138	110	92	79	69
9,5	316	237	190	158	135	119	253	190	152	126	108	95	237	178	142	119	102	89	211	158	126	105	90	79
10	362	272	217	181	155	136	290	217	174	145	124	109	272	204	163	136	116	102	242	181	145	121	104	91
10,5	409	307	246	205	175	154	328	246	197	164	140	123	307	230	184	154	132	115	273	205	164	136	117	102
11	468	351	281	234	200	175	374	281	224	187	160	140	351	263	210	175	150	132	312	234	187	156	134	117
11,5	499	374	299	250	214	187	399	299	240	200	171	150	374	281	225	187	160	140	333	250	200	166	143	125
12	583	437	350	291	250	218	466	350	280	233	200	175	437	328	262	218	187	164	388	291	233	194	166	146
12,5	654	490	392	327	280	245	523	392	314	262	224	196	490	368	294	245	210	184	436	327	262	218	187	163
13	736	552	442	368	316	276	589	442	353	294	252	221	552	414	331	276	237	207	491	368	294	245	210	184
13,5	809	607	485	405	347	303	647	485	388	324	277	243	607	455	364	303	260	228	539	405	324	270	231	202
14	898	674	539	449	385	337	718	539	431	359	308	269	674	505	404	337	289	253	599	449	359	299	257	225
14,5	988	741	593	494	423	370	790	593	474	395	339	296	741	556	445	370	318	278	659	494	395	329	282	247
15	1075	807	645	538	461	403	860	645	516	430	369	323	807	605	484	403	346	302	717	538	430	358	307	269
15,5	1176	882	706	588	504	441	941	706	565	470	403	353	882	662	529	441	378	331	784	588	470	392	336	294
16	1262	946	757	631	541	473	1009	757	606	505	433	379	946	710	568	473	406	355	841	631	505	421	361	315
16,5	1368	1026	821	684	586	513	1094	821	656	547	469	410	1026	769	615	513	440	385	912	684	547	456	391	342
17	1513	1135	908	756	648	567	1210	908	726	605	519	454	1135	851	681	567	486	425	1009	756	605	504	432	378
17,5	1589	1192	953	794	681	596	1271	953	763	635	545	477	1192	894	715	596	511	447	1059	794	635	530	454	397
18	1617	1213	970	808	693	606	1293	970	776	647	554	485	1213	909	728	606	520	455	1078	808	647	539	462	404
18,5	1656	1242	994	828	710	621	1325	994	795	662	568	497	1242	931	745	621	532	466	1104	828	662	552	473	414

LD 0 - Lopatka 0 długa
LD I - Lopatka I długa
LK 0 - Lopatka 0 krótka
LK I - Lopatka I krótka



Tabela wysiewu

SIPMA RN 610 ANTEK

Tarcza: 430

Lopatki I



NS 26 - 13 Saletrosan 26

Grupa Azoty Zakłady Azotowe Tarnów S.A.

Formuła nawozu: N(S) 26-(13)
Klasa ziarnowa: granule 2-6 mm, nie mniej niż 95%
Gęstość nasypowa: 0,98 kg/dm³

Szerokość robocza	20 m						21 m						24 m					
Typ i ustawienie lopatek	LD I - 2,5						LD I - 3,1						LD I - 3,2					
	LK I - 1,4						LK I - 2						LK I - 2					
Obroty	540 obr/min						540 obr/min						540 obr/min					
Dawka wysiewu	kg/ha																	
Nastawa	Prędk. robocza [km/h]						Prędk. robocza [km/h]						Prędk. robocza [km/h]					
	6	8	10	12	14	16	6	8	10	12	14	16	6	8	10	12	14	16
4	28	21	17	14	12	10	26	20	16	13	11	10	23	17	14	12	10	9
4,5	35	26	21	17	15	13	33	25	20	17	14	12	29	22	17	15	12	11
5	42	32	25	21	18	16	40	30	24	20	17	15	35	26	21	18	15	13
5,5	52	39	31	26	22	20	50	37	30	25	21	19	44	33	26	22	19	16
6	62	47	37	31	27	23	59	44	36	30	25	22	52	39	31	26	22	19
6,5	73	55	44	36	31	27	69	52	42	35	30	26	61	46	36	30	26	23
7	89	67	53	44	38	33	85	64	51	42	36	32	74	56	44	37	32	28
7,5	105	79	63	52	45	39	100	75	60	50	43	37	87	65	52	44	37	33
8	120	90	72	60	51	45	114	86	68	57	49	43	100	75	60	50	43	37
8,5	144	108	86	72	62	54	137	103	82	69	59	51	120	90	72	60	51	45
9	165	124	99	83	71	62	157	118	94	79	67	59	138	103	83	69	59	52
9,5	190	142	114	95	81	71	181	135	108	90	77	68	158	119	95	79	68	59
10	217	163	130	109	93	82	207	155	124	104	89	78	181	136	109	91	78	68
10,5	246	184	147	123	105	92	234	175	140	117	100	88	205	154	123	102	88	77
11	281	210	168	140	120	105	267	200	160	134	115	100	234	175	140	117	100	88
11,5	299	225	180	150	128	112	285	214	171	143	122	107	250	187	150	125	107	94
12	350	262	210	175	150	131	333	250	200	166	143	125	291	218	175	146	125	109
12,5	392	294	235	196	168	147	374	280	224	187	160	140	327	245	196	163	140	123
13	442	331	265	221	189	166	421	316	252	210	180	158	368	276	221	184	158	138
13,5	485	364	291	243	208	182	462	347	277	231	198	173	405	303	243	202	173	152
14	539	404	323	269	231	202	513	385	308	257	220	192	449	337	269	225	192	168
14,5	593	445	356	296	254	222	564	423	339	282	242	212	494	370	296	247	212	185
15	645	484	387	323	277	242	614	461	369	307	263	230	538	403	323	269	230	202
15,5	706	529	423	353	302	265	672	504	403	336	288	252	588	441	353	294	252	221
16	757	568	454	379	324	284	721	541	433	361	309	270	631	473	379	315	270	237
16,5	821	615	492	410	352	308	782	586	469	391	335	293	684	513	410	342	293	256
17	908	681	545	454	389	340	864	648	519	432	370	324	756	567	454	378	324	284
17,5	953	715	572	477	409	357	908	681	545	454	389	340	794	596	477	397	340	298
18	970	728	582	485	416	364	924	693	554	462	396	346	808	606	485	404	346	303
18,5	994	745	596	497	426	373	946	710	568	473	406	355	828	621	497	414	355	310

LD 0 - Lopatka 0 długa
LD 1 - Lopatka 1 długa
LK 0 - Lopatka 0 krótka
LK 1 - Lopatka 1 krótka



Tabela wysiewu

SIPMA RN 610 ANTEK

Tarcza: 430

Lopatkki 0



NS 21 - 24 Siarczan Amonu AS 21 MACRO

Grupa Azoty Zakłady Azotowe Tarnów S.A.

Formuła nawozu: N(S) 21(24)
Klasa ziarnowa: frakcja 1-4mm, nie mniej niż 90%
Gęstość nasypowa: 1,025 kg/dm³

Szerokość robocza	10 m						12 m						15 m						16 m						18 m					
Typ i ustawienie lopatek	LD 0 - 2,4						LD 0 - 2,5						LD 0 - 3,1						LD 0 - 3,3						LD 0 - 3,4					
	LK 0 - 1						LK 0 - 1,1						LK 0 - 1,2						LK 0 - 1,3						LK 0 - 1,3					
Obroty	540 obr/min						540 obr/min						540 obr/min						540 obr/min						540 obr/min					
Dawka wysiewu	kg/ha																													
Nastawa	Prędk. robocza [km/h]						Prędk. robocza [km/h]						Prędk. robocza [km/h]						Prędk. robocza [km/h]						Prędk. robocza [km/h]					
	6	8	10	12	14	16	6	8	10	12	14	16	6	8	10	12	14	16	6	8	10	12	14	16	6	8	10	12	14	16
4	96	72	58	48	41	36	80	60	48	40	34	30	64	48	38	32	27	24	60	45	36	30	26	22	53	40	32	27	23	20
4,5	120	90	72	60	51	45	100	75	60	50	43	37	80	60	48	40	34	30	75	56	45	37	32	28	67	50	40	33	29	25
5	148	111	89	74	63	56	123	93	74	62	53	46	99	74	59	49	42	37	93	69	56	46	40	35	82	62	49	41	35	31
5,5	181	135	108	90	77	68	150	113	90	75	64	56	120	90	72	60	52	45	113	85	68	56	48	42	100	75	60	50	43	38
6	215	161	129	108	92	81	179	135	108	90	77	67	143	108	86	72	61	54	135	101	81	67	58	50	120	90	72	60	51	45
6,5	259	194	155	129	111	97	216	162	129	108	92	81	172	129	103	86	74	65	162	121	97	81	69	61	144	108	86	72	62	54
7	310	233	186	155	133	116	259	194	155	129	111	97	207	155	124	103	89	78	194	146	116	97	83	73	172	129	103	86	74	65
7,5	351	263	210	175	150	132	292	219	175	146	125	110	234	175	140	117	100	88	219	164	132	110	94	82	195	146	117	97	84	73
8	424	318	254	212	182	159	353	265	212	177	151	132	283	212	170	141	121	106	265	199	159	132	114	99	236	177	141	118	101	88
8,5	476	357	285	238	204	178	397	297	238	198	170	149	317	238	190	159	136	119	297	223	178	149	127	112	264	198	159	132	113	99
9	562	422	337	281	241	211	469	352	281	234	201	176	375	281	225	187	161	141	352	264	211	176	151	132	312	234	187	156	134	117
9,5	619	464	371	309	265	232	516	387	309	258	221	193	413	309	248	206	177	155	387	290	232	193	166	145	344	258	206	172	147	129
10	709	532	426	355	304	266	591	443	355	296	253	222	473	355	284	236	203	177	443	333	266	222	190	166	394	296	236	197	169	148
10,5	805	604	483	402	345	302	671	503	402	335	287	252	537	402	322	268	230	201	503	377	302	252	216	189	447	335	268	224	192	168
11	898	674	539	449	385	337	749	561	449	374	321	281	599	449	359	299	257	225	561	421	337	281	241	211	499	374	299	250	214	187
11,5	990	742	594	495	424	371	825	618	495	412	353	309	660	495	396	330	283	247	618	464	371	309	265	232	550	412	330	275	236	206
12	1112	834	667	556	477	417	927	695	556	464	397	348	742	556	445	371	318	278	695	521	417	348	298	261	618	464	371	309	265	232
12,5	1191	893	715	596	511	447	993	745	596	496	425	372	794	596	476	397	340	298	745	558	447	372	319	279	662	496	397	331	284	248
13	1367	1026	820	684	586	513	1140	855	684	570	488	427	912	684	547	456	391	342	855	641	513	427	366	320	760	570	456	380	326	285
13,5	1504	1128	902	752	644	564	1253	940	752	627	537	470	1003	752	602	501	430	376	940	705	564	470	403	352	835	627	501	418	358	313
14	1651	1238	991	826	708	619	1376	1032	826	688	590	516	1101	826	660	550	472	413	1032	774	619	516	442	387	917	688	550	459	393	344
14,5	1756	1317	1054	878	753	659	1464	1098	878	732	627	549	1171	878	703	585	502	439	1098	823	659	549	470	412	976	732	585	488	418	366
15	1964	1473	1179	982	842	737	1637	1228	982	818	702	614	1309	982	786	655	561	491	1228	921	737	614	526	460	1091	818	655	546	468	409
15,5	2099	1575	1260	1050	900	787	1750	1312	1050	875	750	656	1400	1050	840	700	600	525	1312	984	787	656	562	492	1166	875	700	583	500	437
16	2285	1713	1371	1142	979	857	1904	1428	1142	952	816	714	1523	1142	914	762	653	571	1428	1071	857	714	612	535	1269	952	762	635	544	476
16,5	2530	1898	1518	1265	1084	949	2109	1582	1265	1054	904	791	1687	1265	1012	843	723	633	1582	1186	949	791	678	593	1406	1054	843	703	602	527
17	2644	1983	1587	1322	1133	992	2204	1653	1322	1102	944	826	1763	1322	1058	881	756	661	1653	1240	992	826	708	620	1469	1102	881	735	630	551
17,5	2887	2165	1732	1444	1237	1083	2406	1804	1444	1203	1031	902	1925	1444	1155	962	825	722	1804	1353	1083	902	773	677	1604	1203	962	802	687	601
18	3041	2281	1825	1521	1303	1140	2534	1901	1521	1267	1086	950	2027	1521	1216	1014	869	760	1901	1426	1140	950	815	713	1689	1267	1014	845	724	634
18,5	3311	2483	1986	1655	1419	1242	2759	2069	1655	1379	1182	1035	2207	1655	1324	1104	946	828	2069	1552	1242	1035	887	776	1839	1379	1104	920	788	690

LD 0 - Lopatka 0 długa
LD 1 - Lopatka 1 długa
LK 0 - Lopatka 0 krótka
LK 1 - Lopatka 1 krótka



Tabela wysiewu

SIPMA RN 610 ANTEK

Tarcza: 430

Lopatki I



NS 21 - 24 Siarczan Amonu AS21 macro

Grupa Azoty Zakłady Azotowe Tarnów S.A.

Formuła nawozu: N(S) 21(24)
Klasa ziarnowa: frakcja 1-4mm, nie mniej niż 90%
Gęstość nasypowa: 1,025 kg/dm³

Szerokość robocza	12 m						15 m						16 m						18 m					
Typ i ustawienie łopatek	LD I - 2						LD I - 2,2						LD I - 2,4						LD I - 3					
	LK I - 0,4						LK I - 1,1						LK I - 1,1						LK I - 1,2					
Obroty	540 obr/min						540 obr/min						540 obr/min						540 obr/min					
Dawka wysiewu	kg/ha																							
Nastawa	Prędk. robocza [km/h]						Prędk. robocza [km/h]						Prędk. robocza [km/h]						Prędk. robocza [km/h]					
	6	8	10	12	14	16	6	8	10	12	14	16	6	8	10	12	14	16	6	8	10	12	14	16
4	80	60	48	40	34	30	64	48	38	32	27	24	60	45	36	30	26	22	53	40	32	27	23	20
4,5	100	75	60	50	43	37	80	60	48	40	34	30	75	56	45	37	32	28	67	50	40	33	29	25
5	123	93	74	62	53	46	99	74	59	49	42	37	93	69	56	46	40	35	82	62	49	41	35	31
5,5	150	113	90	75	64	56	120	90	72	60	52	45	113	85	68	56	48	42	100	75	60	50	43	38
6	179	135	108	90	77	67	143	108	86	72	61	54	135	101	81	67	58	50	120	90	72	60	51	45
6,5	216	162	129	108	92	81	172	129	103	86	74	65	162	121	97	81	69	61	144	108	86	72	62	54
7	259	194	155	129	111	97	207	155	124	103	89	78	194	146	116	97	83	73	172	129	103	86	74	65
7,5	292	219	175	146	125	110	234	175	140	117	100	88	219	164	132	110	94	82	195	146	117	97	84	73
8	353	265	212	177	151	132	283	212	170	141	121	106	265	199	159	132	114	99	236	177	141	118	101	88
8,5	397	297	238	198	170	149	317	238	190	159	136	119	297	223	178	149	127	112	264	198	159	132	113	99
9	469	352	281	234	201	176	375	281	225	187	161	141	352	264	211	176	151	132	312	234	187	156	134	117
9,5	516	387	309	258	221	193	413	309	248	206	177	155	387	290	232	193	166	145	344	258	206	172	147	129
10	591	443	355	296	253	222	473	355	284	236	203	177	443	333	266	222	190	166	394	296	236	197	169	148
10,5	671	503	402	335	287	252	537	402	322	268	230	201	503	377	302	252	216	189	447	335	268	224	192	168
11	749	561	449	374	321	281	599	449	359	299	257	225	561	421	337	281	241	211	499	374	299	250	214	187
11,5	825	618	495	412	353	309	660	495	396	330	283	247	618	464	371	309	265	232	550	412	330	275	236	206
12	927	695	556	464	397	348	742	556	445	371	318	278	695	521	417	348	298	261	618	464	371	309	265	232
12,5	993	745	596	496	425	372	794	596	476	397	340	298	745	558	447	372	319	279	662	496	397	331	284	248
13	1140	855	684	570	488	427	912	684	547	456	391	342	855	641	513	427	366	320	760	570	456	380	326	285
13,5	1253	940	752	627	537	470	1003	752	602	501	430	376	940	705	564	470	403	352	835	627	501	418	358	313
14	1376	1032	826	688	590	516	1101	826	660	550	472	413	1032	774	619	516	442	387	917	688	550	459	393	344
14,5	1464	1098	878	732	627	549	1171	878	703	585	502	439	1098	823	659	549	470	412	976	732	585	488	418	366
15	1637	1228	982	818	702	614	1309	982	786	655	561	491	1228	921	737	614	526	460	1091	818	655	546	468	409
15,5	1750	1312	1050	875	750	656	1400	1050	840	700	600	525	1312	984	787	656	562	492	1166	875	700	583	500	437
16	1904	1428	1142	952	816	714	1523	1142	914	762	653	571	1428	1071	857	714	612	535	1269	952	762	635	544	476
16,5	2109	1582	1265	1054	904	791	1687	1265	1012	843	723	633	1582	1186	949	791	678	593	1406	1054	843	703	602	527
17	2204	1653	1322	1102	944	826	1763	1322	1058	881	756	661	1653	1240	992	826	708	620	1469	1102	881	735	630	551
17,5	2406	1804	1444	1203	1031	902	1925	1444	1155	962	825	722	1804	1353	1083	902	773	677	1604	1203	962	802	687	601
18	2534	1901	1521	1267	1086	950	2027	1521	1216	1014	869	760	1901	1426	1140	950	815	713	1689	1267	1014	845	724	634
18,5	2759	2069	1655	1379	1182	1035	2207	1655	1324	1104	946	828	2069	1552	1242	1035	887	776	1839	1379	1104	920	788	690

LD 0 - Łopaska 0 długa
LD I - Łopaska I długa
LK 0 - Łopaska 0 krótka
LK I - Łopaska I krótka



Tabela wysiewu

SIPMA RN 610 ANTEK

Tarcza: 430

Lopatki I



NS 21 - 24 Siarczan Amonu AS21 macro

Grupa Azoty Zakłady Azotowe Tarnów S.A.

Formuła nawozu: N(S) 21(24)
Klasa ziarnowa: frakcja 1-4mm, nie mniej niż 90%
Gęstość nasypowa: 1,025 kg/dm³

Szerokość robocza	20 m						21 m						24 m					
Typ i ustawienie lopatek	LD I - 3,2						LD I - 3,4						LD I - 3,4					
	LK I - 1,2						LK I - 0,4						LK I - 0,4					
Obroty	540 obr/min						540 obr/min						600 obr/min					
Dawka wysiewu	kg/ha																	
Nastawa	Prędk. robocza [km/h]						Prędk. robocza [km/h]						Prędk. robocza [km/h]					
	6	8	10	12	14	16	6	8	10	12	14	16	6	8	10	12	14	16
4	48	36	29	24	21	18	46	34	27	23	20	17	40	30	24	20	17	15
4,5	60	45	36	30	26	22	57	43	34	29	24	21	50	37	30	25	21	19
5	74	56	44	37	32	28	70	53	42	35	30	26	62	46	37	31	26	23
5,5	90	68	54	45	39	34	86	64	52	43	37	32	75	56	45	38	32	28
6	108	81	65	54	46	40	102	77	61	51	44	38	90	67	54	45	38	34
6,5	129	97	78	65	55	49	123	92	74	62	53	46	108	81	65	54	46	40
7	155	116	93	78	67	58	148	111	89	74	63	55	129	97	78	65	55	49
7,5	175	132	105	88	75	66	167	125	100	84	72	63	146	110	88	73	63	55
8	212	159	127	106	91	79	202	151	121	101	87	76	177	132	106	88	76	66
8,5	238	178	143	119	102	89	227	170	136	113	97	85	198	149	119	99	85	74
9	281	211	169	141	121	105	268	201	161	134	115	100	234	176	141	117	100	88
9,5	309	232	186	155	133	116	295	221	177	147	126	111	258	193	155	129	111	97
10	355	266	213	177	152	133	338	253	203	169	145	127	296	222	177	148	127	111
10,5	402	302	241	201	172	151	383	287	230	192	164	144	335	252	201	168	144	126
11	449	337	269	225	192	168	428	321	257	214	183	160	374	281	225	187	160	140
11,5	495	371	297	247	212	186	471	353	283	236	202	177	412	309	247	206	177	155
12	556	417	334	278	238	209	530	397	318	265	227	199	464	348	278	232	199	174
12,5	596	447	357	298	255	223	567	425	340	284	243	213	496	372	298	248	213	186
13	684	513	410	342	293	256	651	488	391	326	279	244	570	427	342	285	244	214
13,5	752	564	451	376	322	282	716	537	430	358	307	269	627	470	376	313	269	235
14	826	619	495	413	354	310	786	590	472	393	337	295	688	516	413	344	295	258
14,5	878	659	527	439	376	329	836	627	502	418	358	314	732	549	439	366	314	274
15	982	737	589	491	421	368	935	702	561	468	401	351	818	614	491	409	351	307
15,5	1050	787	630	525	450	394	1000	750	600	500	428	375	875	656	525	437	375	328
16	1142	857	685	571	490	428	1088	816	653	544	466	408	952	714	571	476	408	357
16,5	1265	949	759	633	542	474	1205	904	723	602	516	452	1054	791	633	527	452	395
17	1322	992	793	661	567	496	1259	944	756	630	540	472	1102	826	661	551	472	413
17,5	1444	1083	866	722	619	541	1375	1031	825	687	589	516	1203	902	722	601	516	451
18	1521	1140	912	760	652	570	1448	1086	869	724	621	543	1267	950	760	634	543	475
18,5	1655	1242	993	828	709	621	1577	1182	946	788	676	591	1379	1035	828	690	591	517

LD 0 - Lopatka 0 długa
LD I - Lopatka I długa
LK 0 - Lopatka 0 krótka
LK I - Lopatka I krótka



Tabela wysiewu

SIPMA RN 610 ANTEK

Tarcza: 430

Lopatkki 0



NS 21 - 24 Siarczan Amonu AS21

Grupa Azoty Zakłady Azotowe Tarnów S.A.

Formuła nawozu: N(S) 21-(24)
Klasa ziarnowa: granule 3,55 mm, nie mniej niż 70%
Gęstość nasypowa: 1,035 kg/dm³

Szerokość robocza	10 m						15 m						16 m						18 m						20 m					
Typ i ustawienie lopatek	LD 0 - 2,3						LD 0 - 2,5						LD 0 - 2,5						LD 0 - 3,1						LD 0 - 3,3					
	LK 0 - 1,4						LK 0 - 1,4						LK 0 - 2,1						LK 0 - 2,1						LK 0 - 2,1					
Obroty	540 obr/min						540 obr/min						540 obr/min						540 obr/min						540 obr/min					
Dawka wysiewu	kg/ha																													
Nastawa	Prędk. robocza [km/h]						Prędk. robocza [km/h]						Prędk. robocza [km/h]						Prędk. robocza [km/h]						Prędk. robocza [km/h]					
	6	8	10	12	14	16	6	8	10	12	14	16	6	8	10	12	14	16	6	8	10	12	14	16	6	8	10	12	14	16
4	77	58	46	38	33	29	51	38	31	26	22	19	48	36	29	24	21	18	43	32	26	21	18	16	38	29	23	19	16	14
4,5	92	69	55	46	40	35	62	46	37	31	26	23	58	43	35	29	25	22	51	38	31	26	22	19	46	35	28	23	20	17
5	117	88	70	59	50	44	78	59	47	39	34	29	73	55	44	37	31	28	65	49	39	33	28	24	59	44	35	29	25	22
5,5	143	107	86	71	61	54	95	71	57	48	41	36	89	67	54	45	38	33	79	60	48	40	34	30	71	54	43	36	31	27
6	166	124	99	83	71	62	110	83	66	55	47	41	104	78	62	52	44	39	92	69	55	46	39	35	83	62	50	41	36	31
6,5	203	152	122	101	87	76	135	101	81	68	58	51	127	95	76	63	54	48	113	84	68	56	48	42	101	76	61	51	43	38
7	246	185	148	123	106	92	164	123	99	82	70	62	154	116	92	77	66	58	137	103	82	68	59	51	123	92	74	62	53	46
7,5	290	217	174	145	124	109	193	145	116	97	83	72	181	136	109	91	78	68	161	121	97	80	69	60	145	109	87	72	62	54
8	332	249	199	166	142	125	222	166	133	111	95	83	208	156	125	104	89	78	185	139	111	92	79	69	166	125	100	83	71	62
8,5	395	296	237	198	169	148	263	198	158	132	113	99	247	185	148	123	106	93	220	165	132	110	94	82	198	148	119	99	85	74
9	452	339	271	226	194	170	302	226	181	151	129	113	283	212	170	141	121	106	251	188	151	126	108	94	226	170	136	113	97	85
9,5	462	346	277	231	198	173	308	231	185	154	132	115	289	217	173	144	124	108	257	192	154	128	110	96	231	173	139	115	99	87
10	581	436	348	290	249	218	387	290	232	194	166	145	363	272	218	181	156	136	323	242	194	161	138	121	290	218	174	145	124	109
10,5	665	499	399	333	285	250	444	333	266	222	190	166	416	312	250	208	178	156	370	277	222	185	158	139	333	250	200	166	143	125
11	764	573	458	382	327	287	509	382	306	255	218	191	478	358	287	239	205	179	424	318	255	212	182	159	382	287	229	191	164	143
11,5	1129	847	678	565	484	424	753	565	452	376	323	282	706	529	424	353	303	265	627	471	376	314	269	235	565	424	339	282	242	212
12	793	595	476	397	340	298	529	397	317	264	227	198	496	372	298	248	213	186	441	331	264	220	189	165	397	298	238	198	170	149
12,5	1041	781	625	521	446	391	694	521	417	347	298	260	651	488	391	325	279	244	579	434	347	289	248	217	521	391	312	260	223	195
13	1165	874	699	582	499	437	776	582	466	388	333	291	728	546	437	364	312	273	647	485	388	324	277	243	582	437	349	291	250	218
13,5	1291	968	774	645	553	484	860	645	516	430	369	323	807	605	484	403	346	302	717	538	430	359	307	269	645	484	387	323	277	242
14	1412	1059	847	706	605	530	941	706	565	471	403	353	883	662	530	441	378	331	784	588	471	392	336	294	706	530	424	353	303	265
14,5	1546	1159	927	773	662	580	1030	773	618	515	442	386	966	725	580	483	414	362	859	644	515	429	368	322	773	580	464	386	331	290
15	1675	1256	1005	837	718	628	1116	837	670	558	478	419	1047	785	628	523	449	392	930	698	558	465	399	349	837	628	502	419	359	314
15,5	1817	1363	1090	909	779	682	1212	909	727	606	519	454	1136	852	682	568	487	426	1010	757	606	505	433	379	909	682	545	454	389	341
16	1925	1444	1155	963	825	722	1284	963	770	642	550	481	1203	903	722	602	516	451	1070	802	642	535	458	401	963	722	578	481	413	361
16,5	2066	1550	1240	1033	885	775	1377	1033	826	689	590	517	1291	968	775	646	553	484	1148	861	689	574	492	430	1033	775	620	517	443	387
17	2378	1783	1427	1189	1019	892	1585	1189	951	793	679	594	1486	1114	892	743	637	557	1321	991	793	660	566	495	1189	892	713	594	509	446
17,5	2570	1928	1542	1285	1101	964	1713	1285	1028	857	734	643	1606	1205	964	803	688	602	1428	1071	857	714	612	535	1285	964	771	643	551	482
18	2741	2056	1644	1370	1175	1028	1827	1370	1096	914	783	685	1713	1285	1028	857	734	642	1523	1142	914	761	653	571	1370	1028	822	685	587	514
18,5	2843	2132	1706	1421	1218	1066	1895	1421	1137	948	812	711	1777	1333	1066	888	761	666	1579	1184	948	790	677	592	1421	1066	853	711	609	533

LD 0 - Lopatka 0 długa
LD 1 - Lopatka I długa
LK 0 - Lopatka 0 krótka
LK 1 - Lopatka I krótka



Tabela wysiewu

SIPMA RN 610 ANTEK

Tarcza: 430

Lopatki I



NS 21 - 24 Siarczan Amonu AS21 select

Grupa Azoty Zakłady Azotowe Tarnów S.A.

Formuła nawozu: N(S) 21-(24)
Klasa ziarnowa: granule 3,55 mm, nie mniej niż 70%
Gęstość nasypowa: 1,035 kg/dm³

Szerokość robocza	12 m						15 m						16 m						18 m					
Typ i ustawienie lopatek	LD I - 1						LD I - 1,2						LD I - 1,4						LD I - 2					
	LK I - 1,3						LK I - 2						LK I - 2						LK I - 2					
Obroty	540 obr/min						540 obr/min						540 obr/min						540 obr/min					
Dawka wysiewu	kg/ha																							
Nastawa	Prędk. robocza [km/h]						Prędk. robocza [km/h]						Prędk. robocza [km/h]						Prędk. robocza [km/h]					
	6	8	10	12	14	16	6	8	10	12	14	16	6	8	10	12	14	16	6	8	10	12	14	16
4	64	48	38	32	27	24	51	38	31	26	22	19	48	36	29	24	21	18	43	32	26	21	18	16
4,5	77	58	46	38	33	29	62	46	37	31	26	23	58	43	35	29	25	22	51	38	31	26	22	19
5	98	73	59	49	42	37	78	59	47	39	34	29	73	55	44	37	31	28	65	49	39	33	28	24
5,5	119	89	71	60	51	45	95	71	57	48	41	36	89	67	54	45	38	33	79	60	48	40	34	30
6	138	104	83	69	59	52	110	83	66	55	47	41	104	78	62	52	44	39	92	69	55	46	39	35
6,5	169	127	101	84	72	63	135	101	81	68	58	51	127	95	76	63	54	48	113	84	68	56	48	42
7	205	154	123	103	88	77	164	123	99	82	70	62	154	116	92	77	66	58	137	103	82	68	59	51
7,5	241	181	145	121	103	91	193	145	116	97	83	72	181	136	109	91	78	68	161	121	97	80	69	60
8	277	208	166	139	119	104	222	166	133	111	95	83	208	156	125	104	89	78	185	139	111	92	79	69
8,5	329	247	198	165	141	123	263	198	158	132	113	99	247	185	148	123	106	93	220	165	132	110	94	82
9	377	283	226	188	162	141	302	226	181	151	129	113	283	212	170	141	121	106	251	188	151	126	108	94
9,5	385	289	231	192	165	144	308	231	185	154	132	115	289	217	173	144	124	108	257	192	154	128	110	96
10	484	363	290	242	207	181	387	290	232	194	166	145	363	272	218	181	156	136	323	242	194	161	138	121
10,5	555	416	333	277	238	208	444	333	266	222	190	166	416	312	250	208	178	156	370	277	222	185	158	139
11	637	478	382	318	273	239	509	382	306	255	218	191	478	358	287	239	205	179	424	318	255	212	182	159
11,5	941	706	565	471	403	353	753	565	452	376	323	282	706	529	424	353	303	265	627	471	376	314	269	235
12	661	496	397	331	283	248	529	397	317	264	227	198	496	372	298	248	213	186	441	331	264	220	189	165
12,5	868	651	521	434	372	325	694	521	417	347	298	260	651	488	391	325	279	244	579	434	347	289	248	217
13	971	728	582	485	416	364	776	582	466	388	333	291	728	546	437	364	312	273	647	485	388	324	277	243
13,5	1076	807	645	538	461	403	860	645	516	430	369	323	807	605	484	403	346	302	717	538	430	359	307	269
14	1177	883	706	588	504	441	941	706	565	471	403	353	883	662	530	441	378	331	784	588	471	392	336	294
14,5	1288	966	773	644	552	483	1030	773	618	515	442	386	966	725	580	483	414	362	859	644	515	429	368	322
15	1396	1047	837	698	598	523	1116	837	670	558	478	419	1047	785	628	523	449	392	930	698	558	465	399	349
15,5	1515	1136	909	757	649	568	1212	909	727	606	519	454	1136	852	682	568	487	426	1010	757	606	505	433	379
16	1605	1203	963	802	688	602	1284	963	770	642	550	481	1203	903	722	602	516	451	1070	802	642	535	458	401
16,5	1722	1291	1033	861	738	646	1377	1033	826	689	590	517	1291	968	775	646	553	484	1148	861	689	574	492	430
17	1981	1486	1189	991	849	743	1585	1189	951	793	679	594	1486	1114	892	743	637	557	1321	991	793	660	566	495
17,5	2142	1606	1285	1071	918	803	1713	1285	1028	857	734	643	1606	1205	964	803	688	602	1428	1071	857	714	612	535
18	2284	1713	1370	1142	979	857	1827	1370	1096	914	783	685	1713	1285	1028	857	734	642	1523	1142	914	761	653	571
18,5	2369	1777	1421	1184	1015	888	1895	1421	1137	948	812	711	1777	1333	1066	888	761	666	1579	1184	948	790	677	592

LD 0 - Lopatka 0 długa
LD I - Lopatka I długa
LK 0 - Lopatka 0 krótka
LK I - Lopatka I krótka



Tabela wysiewu

SIPMA RN 610 ANTEK

Tarcza: 430

Lopatki I



NS 21 - 24 Siarczan Amonu AS21 select

Grupa Azoty Zakłady Azotowe Tarnów S.A.

Formuła nawozu: N(S) 21-(24)
Klasa ziarnowa: granule 3,55 mm, nie mniej niż 70%
Gęstość nasypowa: 1,035 kg/dm³

Szerokość robocza	20 m						21 m						24 m					
Typ i ustawienie lopatek	LD I - 2,2						LD I - 2,4						LD I - 3					
	LK I - 2						LK I - 2						LK I - 2					
Obroty	540 obr/min						540 obr/min						540 obr/min					
Dawka wysiewu	kg/ha																	
Nastawa	Prędk. robocza [km/h]						Prędk. robocza [km/h]						Prędk. robocza [km/h]					
	6	8	10	12	14	16	6	8	10	12	14	16	6	8	10	12	14	16
4	38	29	23	19	16	14	37	27	22	18	16	14	32	24	19	16	14	12
4,5	46	35	28	23	20	17	44	33	26	22	19	16	38	29	23	19	16	14
5	59	44	35	29	25	22	56	42	34	28	24	21	49	37	29	24	21	18
5,5	71	54	43	36	31	27	68	51	41	34	29	26	60	45	36	30	26	22
6	83	62	50	41	36	31	79	59	47	39	34	30	69	52	41	35	30	26
6,5	101	76	61	51	43	38	97	72	58	48	41	36	84	63	51	42	36	32
7	123	92	74	62	53	46	117	88	70	59	50	44	103	77	62	51	44	39
7,5	145	109	87	72	62	54	138	103	83	69	59	52	121	91	72	60	52	45
8	166	125	100	83	71	62	158	119	95	79	68	59	139	104	83	69	59	52
8,5	198	148	119	99	85	74	188	141	113	94	81	71	165	123	99	82	71	62
9	226	170	136	113	97	85	215	162	129	108	92	81	188	141	113	94	81	71
9,5	231	173	139	115	99	87	220	165	132	110	94	82	192	144	115	96	82	72
10	290	218	174	145	124	109	277	207	166	138	119	104	242	181	145	121	104	91
10,5	333	250	200	166	143	125	317	238	190	158	136	119	277	208	166	139	119	104
11	382	287	229	191	164	143	364	273	218	182	156	136	318	239	191	159	136	119
11,5	565	424	339	282	242	212	538	403	323	269	231	202	471	353	282	235	202	176
12	397	298	238	198	170	149	378	283	227	189	162	142	331	248	198	165	142	124
12,5	521	391	312	260	223	195	496	372	298	248	213	186	434	325	260	217	186	163
13	582	437	349	291	250	218	555	416	333	277	238	208	485	364	291	243	208	182
13,5	645	484	387	323	277	242	615	461	369	307	263	230	538	403	323	269	230	202
14	706	530	424	353	303	265	672	504	403	336	288	252	588	441	353	294	252	221
14,5	773	580	464	386	331	290	736	552	442	368	315	276	644	483	386	322	276	242
15	837	628	502	419	359	314	797	598	478	399	342	299	698	523	419	349	299	262
15,5	909	682	545	454	389	341	865	649	519	433	371	325	757	568	454	379	325	284
16	963	722	578	481	413	361	917	688	550	458	393	344	802	602	481	401	344	301
16,5	1033	775	620	517	443	387	984	738	590	492	422	369	861	646	517	430	369	323
17	1189	892	713	594	509	446	1132	849	679	566	485	425	991	743	594	495	425	371
17,5	1285	964	771	643	551	482	1224	918	734	612	524	459	1071	803	643	535	459	402
18	1370	1028	822	685	587	514	1305	979	783	653	559	489	1142	857	685	571	489	428
18,5	1421	1066	853	711	609	533	1354	1015	812	677	580	508	1184	888	711	592	508	444

LD 0 - Lopatka 0 długa
LD 1 - Lopatka I długa
LK 0 - Lopatka 0 krótka
LK 1 - Lopatka I krótka



Tabela wysiewu

SIPMA RN 610 ANTEK

Tarcza: 430

Lopatki 0



N 34 Saetra Amonowa PULAN

Grupa Azoty Zakłady Azotowe „Puławy” S.A.

Formuła nawozu: N 34
Klasa ziarnowa: granule 1-4 mm - nie mniej niż 95%
Gęstość nasypowa: 0,98 – 1,06 kg/dm³ N

Szerokość robocza	10 m						12 m						15 m						16 m						18 m					
Typ i ustawienie łopatek	LD 0 - 2						LD 0 - 2,2						LD 0 - 2,4						LD 0 - 3						LD 0 - 3,3					
	LK 0 - 1						LK 0 - 2						LK 0 - 2,3						LK 0 - 3						LK 0 - 3,1					
Obroty	540 obr/min						540 obr/min						540 obr/min						540 obr/min						540 obr/min					
Dawka wysiewu	kg/ha																													
Nastawa	Prędk. robocza [km/h]						Prędk. robocza [km/h]						Prędk. robocza [km/h]						Prędk. robocza [km/h]						Prędk. robocza [km/h]					
	6	8	10	12	14	16	6	8	10	12	14	16	6	8	10	12	14	16	6	8	10	12	14	16	6	8	10	12	14	16
4	141	106	85	70	60	53	117	88	70	59	50	44	94	70	56	47	40	35	88	66	53	44	38	33	78	59	47	39	34	29
4,5	174	130	104	87	75	65	145	109	87	72	62	54	116	87	70	58	50	43	109	82	65	54	47	41	97	72	58	48	41	36
5	208	156	125	104	89	78	173	130	104	87	74	65	139	104	83	69	59	52	130	97	78	65	56	49	115	87	69	58	49	43
5,5	247	185	148	123	106	93	206	154	123	103	88	77	164	123	99	82	70	62	154	116	93	77	66	58	137	103	82	69	59	51
6	295	222	177	148	127	111	246	185	148	123	105	92	197	148	118	98	84	74	185	138	111	92	79	69	164	123	98	82	70	62
6,5	349	261	209	174	149	131	290	218	174	145	124	109	232	174	139	116	100	87	218	163	131	109	93	82	194	145	116	97	83	73
7	408	306	245	204	175	153	340	255	204	170	146	128	272	204	163	136	117	102	255	191	153	128	109	96	227	170	136	113	97	85
7,5	470	353	282	235	202	176	392	294	235	196	168	147	314	235	188	157	134	118	294	220	176	147	126	110	261	196	157	131	112	98
8	549	412	329	274	235	206	457	343	274	229	196	172	366	274	220	183	157	137	343	257	206	172	147	129	305	229	183	152	131	114
8,5	629	472	377	314	269	236	524	393	314	262	225	196	419	314	251	210	180	157	393	295	236	196	168	147	349	262	210	175	150	131
9	715	536	429	357	306	268	596	447	357	298	255	223	477	357	286	238	204	179	447	335	268	223	191	168	397	298	238	199	170	149
9,5	806	604	484	403	345	302	672	504	403	336	288	252	537	403	322	269	230	201	504	378	302	252	216	189	448	336	269	224	192	168
10	915	686	549	458	392	343	763	572	458	381	327	286	610	458	366	305	261	229	572	429	343	286	245	215	508	381	305	254	218	191
10,5	1017	763	610	508	436	381	847	636	508	424	363	318	678	508	407	339	291	254	636	477	381	318	272	238	565	424	339	282	242	212
11	1139	854	683	569	488	427	949	712	569	474	407	356	759	569	455	380	325	285	712	534	427	356	305	267	633	474	380	316	271	237
11,5	1271	953	762	635	545	476	1059	794	635	529	454	397	847	635	508	424	363	318	794	596	476	397	340	298	706	529	424	353	303	265
12	1385	1038	831	692	593	519	1154	865	692	577	494	433	923	692	554	462	396	346	865	649	519	433	371	325	769	577	462	385	330	288
12,5	1532	1149	919	766	656	574	1276	957	766	638	547	479	1021	766	613	511	438	383	957	718	574	479	410	359	851	638	511	425	365	319
13	1681	1260	1008	840	720	630	1401	1050	840	700	600	525	1120	840	672	560	480	420	1050	788	630	525	450	394	934	700	560	467	400	350
13,5	1831	1373	1099	916	785	687	1526	1144	916	763	654	572	1221	916	732	610	523	458	1144	858	687	572	490	429	1017	763	610	509	436	381
14	2049	1537	1229	1024	878	768	1707	1281	1024	854	732	640	1366	1024	820	683	585	512	1281	960	768	640	549	480	1138	854	683	569	488	427
14,5	2195	1646	1317	1097	941	823	1829	1372	1097	915	784	686	1463	1097	878	732	627	549	1372	1029	823	686	588	514	1219	915	732	610	523	457
15	2388	1791	1433	1194	1023	895	1990	1492	1194	995	853	746	1592	1194	955	796	682	597	1492	1119	895	746	640	560	1327	995	796	663	569	497
15,5	2591	1943	1554	1295	1110	972	2159	1619	1295	1080	925	810	1727	1295	1036	864	740	648	1619	1214	972	810	694	607	1439	1080	864	720	617	540
16	2832	2124	1699	1416	1214	1062	2360	1770	1416	1180	1011	885	1888	1416	1133	944	809	708	1770	1327	1062	885	759	664	1573	1180	944	787	674	590
16,5	2907	2180	1744	1453	1246	1090	2422	1817	1453	1211	1038	908	1938	1453	1163	969	830	727	1817	1363	1090	908	779	681	1615	1211	969	807	692	606
17	3157	2368	1894	1579	1353	1184	2631	1973	1579	1315	1128	987	2105	1579	1263	1052	902	789	1973	1480	1184	987	846	740	1754	1315	1052	877	752	658
17,5	3274	2455	1964	1637	1403	1228	2728	2046	1637	1364	1169	1023	2183	1637	1310	1091	935	818	2046	1535	1228	1023	877	767	1819	1364	1091	909	779	682
18	3379	2534	2027	1689	1448	1267	2815	2112	1689	1408	1207	1056	2252	1689	1351	1126	965	845	2112	1584	1267	1056	905	792	1877	1408	1126	938	804	704
18,5	3447	2585	2068	1723	1477	1293	2872	2154	1723	1436	1231	1077	2298	1723	1379	1149	985	862	2154	1616	1293	1077	923	808	1915	1436	1149	957	821	718

LD 0 - Łopatka 0 długa
LD 1 - Łopatka I długa
LK 0 - Łopatka 0 krótka
LK 1 - Łopatka I krótka



Tabela wysiewu

SIPMA RN 610 ANTEK

Tarcza: 430

Lopatki I



N 34 Saletra Amonowa PULAN

Grupa Azoty Zakłady Azotowe „Puławy” S.A.

Formuła nawozu: N 34
Klasa ziarnowa: granule 1-4 mm - nie mniej niż 95%
Gęstość nasypowa: 0,98 - 1,06 kg/dm³ N

Szerokość robocza	12 m						15 m						16 m					
Typ i ustawienie łopatek	LD I - 3,2						LD I - 3,2						LD I - 3,4					
	LK I - 1,2						LK I - 2						LK I - 2,2					
Obroty	540 obr/min						540 obr/min						540 obr/min					
Dawka wysiewu	kg/ha																	
Nastawa	Prędk. robocza [km/h]						Prędk. robocza [km/h]						Prędk. robocza [km/h]					
	6	8	10	12	14	16	6	8	10	12	14	16	6	8	10	12	14	16
4	117	88	70	59	50	44	94	70	56	47	40	35	88	66	53	44	38	33
4,5	145	109	87	72	62	54	116	87	70	58	50	43	109	82	65	54	47	41
5	173	130	104	87	74	65	139	104	83	69	59	52	130	97	78	65	56	49
5,5	206	154	123	103	88	77	164	123	99	82	70	62	154	116	93	77	66	58
6	246	185	148	123	105	92	197	148	118	98	84	74	185	138	111	92	79	69
6,5	290	218	174	145	124	109	232	174	139	116	100	87	218	163	131	109	93	82
7	340	255	204	170	146	128	272	204	163	136	117	102	255	191	153	128	109	96
7,5	392	294	235	196	168	147	314	235	188	157	134	118	294	220	176	147	126	110
8	457	343	274	229	196	172	366	274	220	183	157	137	343	257	206	172	147	129
8,5	524	393	314	262	225	196	419	314	251	210	180	157	393	295	236	196	168	147
9	596	447	357	298	255	223	477	357	286	238	204	179	447	335	268	223	191	168
9,5	672	504	403	336	288	252	537	403	322	269	230	201	504	378	302	252	216	189
10	763	572	458	381	327	286	610	458	366	305	261	229	572	429	343	286	245	215
10,5	847	636	508	424	363	318	678	508	407	339	291	254	636	477	381	318	272	238
11	949	712	569	474	407	356	759	569	455	380	325	285	712	534	427	356	305	267
11,5	1059	794	635	529	454	397	847	635	508	424	363	318	794	596	476	397	340	298
12	1154	865	692	577	494	433	923	692	554	462	396	346	865	649	519	433	371	325
12,5	1276	957	766	638	547	479	1021	766	613	511	438	383	957	718	574	479	410	359
13	1401	1050	840	700	600	525	1120	840	672	560	480	420	1050	788	630	525	450	394
13,5	1526	1144	916	763	654	572	1221	916	732	610	523	458	1144	858	687	572	490	429
14	1707	1281	1024	854	732	640	1366	1024	820	683	585	512	1281	960	768	640	549	480
14,5	1829	1372	1097	915	784	686	1463	1097	878	732	627	549	1372	1029	823	686	588	514
15	1990	1492	1194	995	853	746	1592	1194	955	796	682	597	1492	1119	895	746	640	560
15,5	2159	1619	1295	1080	925	810	1727	1295	1036	864	740	648	1619	1214	972	810	694	607
16	2360	1770	1416	1180	1011	885	1888	1416	1133	944	809	708	1770	1327	1062	885	759	664
16,5	2422	1817	1453	1211	1038	908	1938	1453	1163	969	830	727	1817	1363	1090	908	779	681
17	2631	1973	1579	1315	1128	987	2105	1579	1263	1052	902	789	1973	1480	1184	987	846	740
17,5	2728	2046	1637	1364	1169	1023	2183	1637	1310	1091	935	818	2046	1535	1228	1023	877	767
18	2815	2112	1689	1408	1207	1056	2252	1689	1351	1126	965	845	2112	1584	1267	1056	905	792
18,5	2872	2154	1723	1436	1231	1077	2298	1723	1379	1149	985	862	2154	1616	1293	1077	923	808

LD I - Łopatką I długa
LD II - Łopatką II długa
LK I - Łopatką I krótką
LK II - Łopatką II krótką



Tabela wysiewu

SIPMA RN 610 ANTEK

Tarcza: 430

Lopatki I



N 34 Saletra Amonowa PULAN

Grupa Azoty Zakłady Azotowe „Puławy” S.A.

Formuła nawozu: N 34
Klasa ziarnowa: granulę 1-4 mm - nie mniej niż 95%
Gęstość nasypowa: 0,98 – 1,06 kg/dm³ N

Szerokość robocza	18 m						20 m						21 m					
Typ i ustawienie lopatek	LD I - 4						LD I - 4						LD I - 4					
	LK I - 3						LK I - 3,2						LK I - 3,4					
Obroty	540 obr/min						540 obr/min						540 obr/min					
Dawka wysiewu	kg/ha																	
Nastawa	Prędk. robocza [km/h]						Prędk. robocza [km/h]						Prędk. robocza [km/h]					
	6	8	10	12	14	16	6	8	10	12	14	16	6	8	10	12	14	16
4	78	59	47	39	34	29	70	53	42	35	30	26	67	50	40	34	29	25
4,5	97	72	58	48	41	36	87	65	52	43	37	33	83	62	50	41	35	31
5	115	87	69	58	49	43	104	78	62	52	45	39	99	74	59	49	42	37
5,5	137	103	82	69	59	51	123	93	74	62	53	46	117	88	70	59	50	44
6	164	123	98	82	70	62	148	111	89	74	63	55	141	105	84	70	60	53
6,5	194	145	116	97	83	73	174	131	105	87	75	65	166	124	100	83	71	62
7	227	170	136	113	97	85	204	153	122	102	87	77	194	146	117	97	83	73
7,5	261	196	157	131	112	98	235	176	141	118	101	88	224	168	134	112	96	84
8	305	229	183	152	131	114	274	206	165	137	118	103	261	196	157	131	112	98
8,5	349	262	210	175	150	131	314	236	189	157	135	118	299	225	180	150	128	112
9	397	298	238	199	170	149	357	268	214	179	153	134	340	255	204	170	146	128
9,5	448	336	269	224	192	168	403	302	242	201	173	151	384	288	230	192	164	144
10	508	381	305	254	218	191	458	343	275	229	196	172	436	327	261	218	187	163
10,5	565	424	339	282	242	212	508	381	305	254	218	191	484	363	291	242	208	182
11	633	474	380	316	271	237	569	427	342	285	244	213	542	407	325	271	232	203
11,5	706	529	424	353	303	265	635	476	381	318	272	238	605	454	363	303	259	227
12	769	577	462	385	330	288	692	519	415	346	297	260	659	494	396	330	283	247
12,5	851	638	511	425	365	319	766	574	460	383	328	287	729	547	438	365	313	274
13	934	700	560	467	400	350	840	630	504	420	360	315	800	600	480	400	343	300
13,5	1017	763	610	509	436	381	916	687	549	458	392	343	872	654	523	436	374	327
14	1138	854	683	569	488	427	1024	768	615	512	439	384	976	732	585	488	418	366
14,5	1219	915	732	610	523	457	1097	823	658	549	470	412	1045	784	627	523	448	392
15	1327	995	796	663	569	497	1194	895	716	597	512	448	1137	853	682	569	487	426
15,5	1439	1080	864	720	617	540	1295	972	777	648	555	486	1234	925	740	617	529	463
16	1573	1180	944	787	674	590	1416	1062	850	708	607	531	1348	1011	809	674	578	506
16,5	1615	1211	969	807	692	606	1453	1090	872	727	623	545	1384	1038	830	692	593	519
17	1754	1315	1052	877	752	658	1579	1184	947	789	677	592	1503	1128	902	752	644	564
17,5	1819	1364	1091	909	779	682	1637	1228	982	818	702	614	1559	1169	935	779	668	585
18	1877	1408	1126	938	804	704	1689	1267	1014	845	724	633	1609	1207	965	804	689	603
18,5	1915	1436	1149	957	821	718	1723	1293	1034	862	739	646	1641	1231	985	821	703	615

LD I - Łopatka I długa
LD II - Łopatka II długa
LK I - Łopatka I krótka
LK II - Łopatka II krótka



Tabela wysiewu

SIPMA RN 610 ANTEK

Tarcza: 430

Lopatki 0



N 46 Mocznik PULGRAN

Grupa Azoty Zakłady Azotowe „Puławy” S.A.

Zawartość azotu w formie amidowej (N): 46%
Zawartość biuretu: nie więcej niż 1,2%
Skład ziarnowy: 3-5 mm, min. 90%.

Szerokość robocza	10 m						12 m						15 m						16 m						18 m					
Typ i ustawienie łopatek	LD 0 - 1,2						LD 0 - 1,5						LD 0 - 2,3						LD 0 - 2,5						LD 0 - 3,3					
	LK 0 - 0,3						LK 0 - 1,1						LK 0 - 1,1						LK 0 - 1,2						LK 0 - 1,2					
Obroty	540 obr/min						540 obr/min						540 obr/min						540 obr/min						540 obr/min					
Dawka wysiewu	kg/ha																													
Nastawa	Prędk. robocza [km/h]						Prędk. robocza [km/h]						Prędk. robocza [km/h]						Prędk. robocza [km/h]						Prędk. robocza [km/h]					
	6	8	10	12	14	16	6	8	10	12	14	16	6	8	10	12	14	16	6	8	10	12	14	16	6	8	10	12	14	16
4	64	48	38	32	27	24	53	40	32	26	23	20	42	32	25	21	18	16	40	30	24	20	17	15	35	26	21	18	15	13
4,5	79	60	48	40	34	30	66	50	40	33	28	25	53	40	32	26	23	20	50	37	30	25	21	19	44	33	26	22	19	17
5	95	72	57	48	41	36	80	60	48	40	34	30	64	48	38	32	27	24	60	45	36	30	26	22	53	40	32	27	23	20
5,5	115	86	69	58	49	43	96	72	58	48	41	36	77	58	46	38	33	29	72	54	43	36	31	27	64	48	38	32	27	24
6	137	103	82	69	59	51	114	86	69	57	49	43	91	69	55	46	39	34	86	64	51	43	37	32	76	57	46	38	33	29
6,5	167	125	100	83	71	62	139	104	83	69	59	52	111	83	67	56	48	42	104	78	62	52	45	39	93	69	56	46	40	35
7	195	146	117	97	83	73	162	122	97	81	70	61	130	97	78	65	56	49	122	91	73	61	52	46	108	81	65	54	46	41
7,5	231	173	139	116	99	87	193	145	116	96	83	72	154	116	93	77	66	58	145	108	87	72	62	54	128	96	77	64	55	48
8	270	202	162	135	116	101	225	169	135	112	96	84	180	135	108	90	77	67	169	126	101	84	72	63	150	112	90	75	64	56
8,5	314	236	189	157	135	118	262	196	157	131	112	98	209	157	126	105	90	79	196	147	118	98	84	74	175	131	105	87	75	65
9	364	273	218	182	156	136	303	227	182	152	130	114	242	182	145	121	104	91	227	170	136	114	97	85	202	152	121	101	87	76
9,5	407	305	244	204	175	153	339	255	204	170	145	127	271	204	163	136	116	102	255	191	153	127	109	95	226	170	136	113	97	85
10	463	347	278	231	198	174	386	289	231	193	165	145	309	231	185	154	132	116	289	217	174	145	124	109	257	193	154	129	110	96
10,5	525	394	315	263	225	197	438	328	263	219	188	164	350	263	210	175	150	131	328	246	197	164	141	123	292	219	175	146	125	109
11	589	442	354	295	253	221	491	368	295	246	210	184	393	295	236	196	168	147	368	276	221	184	158	138	327	246	196	164	140	123
11,5	649	487	389	324	278	243	541	405	324	270	232	203	432	324	259	216	185	162	405	304	243	203	174	152	360	270	216	180	154	135
12	723	543	434	362	310	271	603	452	362	301	258	226	482	362	289	241	207	181	452	339	271	226	194	170	402	301	241	201	172	151
12,5	805	604	483	402	345	302	671	503	402	335	287	252	537	402	322	268	230	201	503	377	302	252	216	189	447	335	268	224	192	168
13	888	666	533	444	381	333	740	555	444	370	317	278	592	444	355	296	254	222	555	416	333	278	238	208	493	370	296	247	211	185
13,5	988	741	593	494	424	371	824	618	494	412	353	309	659	494	395	329	282	247	618	463	371	309	265	232	549	412	329	275	235	206
14	1066	799	639	533	457	400	888	666	533	444	381	333	711	533	426	355	305	266	666	500	400	333	285	250	592	444	355	296	254	222
14,5	1184	888	710	592	507	444	987	740	592	493	423	370	789	592	474	395	338	296	740	555	444	370	317	277	658	493	395	329	282	247
15	1346	1010	808	673	577	505	1122	842	673	561	481	421	898	673	539	449	385	337	842	631	505	421	361	316	748	561	449	374	321	281
15,5	1408	1056	845	704	603	528	1173	880	704	587	503	440	939	704	563	469	402	352	880	660	528	440	377	330	782	587	469	391	335	293
16	1512	1134	907	756	648	567	1260	945	756	630	540	472	1008	756	605	504	432	378	945	709	567	472	405	354	840	630	504	420	360	315
16,5	1636	1227	981	818	701	613	1363	1022	818	682	584	511	1091	818	654	545	467	409	1022	767	613	511	438	383	909	682	545	454	389	341
17	1752	1314	1051	876	751	657	1460	1095	876	730	626	547	1168	876	701	584	501	438	1095	821	657	547	469	411	973	730	584	487	417	365
17,5	1875	1406	1125	938	804	703	1563	1172	938	781	670	586	1250	938	750	625	536	469	1172	879	703	586	502	440	1042	781	625	521	446	391
18	1963	1472	1178	982	841	736	1636	1227	982	818	701	613	1309	982	785	654	561	491	1227	920	736	613	526	460	1091	818	654	545	467	409
18,5	2101	1575	1260	1050	900	788	1751	1313	1050	875	750	656	1400	1050	840	700	600	525	1313	985	788	656	563	492	1167	875	700	584	500	438

- LD 0 - Łopatka 0 długa
- LD 1 - Łopatka I długa
- LK 0 - Łopatka 0 krótka
- LK 1 - Łopatka I krótka



Tabela wysiewu

SIPMA RN 610 ANTEK

Tarcza: 430

Lopatki I



N 46 Mocznik PULGRAN

Grupa Azoty Zakłady Azotowe „Puławy” S.A.

Zawartość azotu w formie amidowej (N): 46%
Zawartość biuretu: nie więcej niż 1,2%
Skład ziarnowy: 3-5 mm, min. 90%.

Szerokość robocza	12 m						15 m						16 m						18 m					
Typ i ustawienie lopatek	LD I - 2,2						LD I - 2,3						LD I - 2,5						LD I - 3,2					
	LK I - 1,4						LK I - 1,4						LK I - 1,4						LK I - 2,2					
Obroty	540 obr/min						540 obr/min						540 obr/min						540 obr/min					
Dawka wysiewu	kg/ha																							
Nastawa	Prędk. robocza [km/h]						Prędk. robocza [km/h]						Prędk. robocza [km/h]						Prędk. robocza [km/h]					
	6	8	10	12	14	16	6	8	10	12	14	16	6	8	10	12	14	16	6	8	10	12	14	16
4	53	40	32	26	23	20	42	32	25	21	18	16	40	30	24	20	17	15	35	26	21	18	15	13
4,5	66	50	40	33	28	25	53	40	32	26	23	20	50	37	30	25	21	19	44	33	26	22	19	17
5	80	60	48	40	34	30	64	48	38	32	27	24	60	45	36	30	26	22	53	40	32	27	23	20
5,5	96	72	58	48	41	36	77	58	46	38	33	29	72	54	43	36	31	27	64	48	38	32	27	24
6	114	86	69	57	49	43	91	69	55	46	39	34	86	64	51	43	37	32	76	57	46	38	33	29
6,5	139	104	83	69	59	52	111	83	67	56	48	42	104	78	62	52	45	39	93	69	56	46	40	35
7	162	122	97	81	70	61	130	97	78	65	56	49	122	91	73	61	52	46	108	81	65	54	46	41
7,5	193	145	116	96	83	72	154	116	93	77	66	58	145	108	87	72	62	54	128	96	77	64	55	48
8	225	169	135	112	96	84	180	135	108	90	77	67	169	126	101	84	72	63	150	112	90	75	64	56
8,5	262	196	157	131	112	98	209	157	126	105	90	79	196	147	118	98	84	74	175	131	105	87	75	65
9	303	227	182	152	130	114	242	182	145	121	104	91	227	170	136	114	97	85	202	152	121	101	87	76
9,5	339	255	204	170	145	127	271	204	163	136	116	102	255	191	153	127	109	95	226	170	136	113	97	85
10	386	289	231	193	165	145	309	231	185	154	132	116	289	217	174	145	124	109	257	193	154	129	110	96
10,5	438	328	263	219	188	164	350	263	210	175	150	131	328	246	197	164	141	123	292	219	175	146	125	109
11	491	368	295	246	210	184	393	295	236	196	168	147	368	276	221	184	158	138	327	246	196	164	140	123
11,5	541	405	324	270	232	203	432	324	259	216	185	162	405	304	243	203	174	152	360	270	216	180	154	135
12	603	452	362	301	258	226	482	362	289	241	207	181	452	339	271	226	194	170	402	301	241	201	172	151
12,5	671	503	402	335	287	252	537	402	322	268	230	201	503	377	302	252	216	189	447	335	268	224	192	168
13	740	555	444	370	317	278	592	444	355	296	254	222	555	416	333	278	238	208	493	370	296	247	211	185
13,5	824	618	494	412	353	309	659	494	395	329	282	247	618	463	371	309	265	232	549	412	329	275	235	206
14	888	666	533	444	381	333	711	533	426	355	305	266	666	500	400	333	285	250	592	444	355	296	254	222
14,5	987	740	592	493	423	370	789	592	474	395	338	296	740	555	444	370	317	277	658	493	395	329	282	247
15	1122	842	673	561	481	421	898	673	539	449	385	337	842	631	505	421	361	316	748	561	449	374	321	281
15,5	1173	880	704	587	503	440	939	704	563	469	402	352	880	660	528	440	377	330	782	587	469	391	335	293
16	1260	945	756	630	540	472	1008	756	605	504	432	378	945	709	567	472	405	354	840	630	504	420	360	315
16,5	1363	1022	818	682	584	511	1091	818	654	545	467	409	1022	767	613	511	438	383	909	682	545	454	389	341
17	1460	1095	876	730	626	547	1168	876	701	584	501	438	1095	821	657	547	469	411	973	730	584	487	417	365
17,5	1563	1172	938	781	670	586	1250	938	750	625	536	469	1172	879	703	586	502	440	1042	781	625	521	446	391
18	1636	1227	982	818	701	613	1309	982	785	654	561	491	1227	920	736	613	526	460	1091	818	654	545	467	409
18,5	1751	1313	1050	875	750	656	1400	1050	840	700	600	525	1313	985	788	656	563	492	1167	875	700	584	500	438

LD 0 - Lopatka 0 długa
LD I - Lopatka I długa
LK 0 - Lopatka 0 krótka
LK I - Lopatka I krótka



Tabela wysiewu

SIPMA RN 610 ANTEK

Tarcza: 430

Lopatki I



N 46 Mocznik PULGRAN

Grupa Azoty Zakłady Azotowe „Puławy” S.A.

Zawartość azotu w formie amidowej (N): 46%
Zawartość biuretu: nie więcej niż 1,2%
Skład ziarnowy: 3-5 mm, min. 90%.

Szerokość robocza	20 m						21 m						24 m					
Typ i ustawienie lopatek	LD I - 3,4						LD I - 4						LD I - 4					
	LK I - 2,2						LK I - 2						LK I - 2,2					
Obroty	540 obr/min						540 obr/min						600 obr/min					
Dawka wysiewu	kg/ha																	
Nastawa	Prędk. robocza [km/h]						Prędk. robocza [km/h]						Prędk. robocza [km/h]					
	6	8	10	12	14	16	6	8	10	12	14	16	6	8	10	12	14	16
4	32	24	19	16	14	12	30	23	18	15	13	11	26	20	16	13	11	10
4,5	40	30	24	20	17	15	38	28	23	19	16	14	33	25	20	17	14	12
5	48	36	29	24	20	18	45	34	27	23	19	17	40	30	24	20	17	15
5,5	58	43	35	29	25	22	55	41	33	27	23	21	48	36	29	24	21	18
6	69	51	41	34	29	26	65	49	39	33	28	24	57	43	34	29	24	21
6,5	83	62	50	42	36	31	79	59	48	40	34	30	69	52	42	35	30	26
7	97	73	58	49	42	37	93	70	56	46	40	35	81	61	49	41	35	30
7,5	116	87	69	58	50	43	110	83	66	55	47	41	96	72	58	48	41	36
8	135	101	81	67	58	51	128	96	77	64	55	48	112	84	67	56	48	42
8,5	157	118	94	79	67	59	150	112	90	75	64	56	131	98	79	65	56	49
9	182	136	109	91	78	68	173	130	104	87	74	65	152	114	91	76	65	57
9,5	204	153	122	102	87	76	194	145	116	97	83	73	170	127	102	85	73	64
10	231	174	139	116	99	87	220	165	132	110	94	83	193	145	116	96	83	72
10,5	263	197	158	131	113	98	250	188	150	125	107	94	219	164	131	109	94	82
11	295	221	177	147	126	110	281	210	168	140	120	105	246	184	147	123	105	92
11,5	324	243	195	162	139	122	309	232	185	154	132	116	270	203	162	135	116	101
12	362	271	217	181	155	136	345	258	207	172	148	129	301	226	181	151	129	113
12,5	402	302	241	201	172	151	383	287	230	192	164	144	335	252	201	168	144	126
13	444	333	266	222	190	167	423	317	254	211	181	159	370	278	222	185	159	139
13,5	494	371	296	247	212	185	471	353	282	235	202	176	412	309	247	206	176	154
14	533	400	320	266	228	200	508	381	305	254	218	190	444	333	266	222	190	167
14,5	592	444	355	296	254	222	564	423	338	282	242	211	493	370	296	247	211	185
15	673	505	404	337	289	252	641	481	385	321	275	240	561	421	337	281	240	210
15,5	704	528	422	352	302	264	670	503	402	335	287	251	587	440	352	293	251	220
16	756	567	454	378	324	283	720	540	432	360	309	270	630	472	378	315	270	236
16,5	818	613	491	409	351	307	779	584	467	389	334	292	682	511	409	341	292	256
17	876	657	526	438	375	328	834	626	501	417	358	313	730	547	438	365	313	274
17,5	938	703	563	469	402	352	893	670	536	446	383	335	781	586	469	391	335	293
18	982	736	589	491	421	368	935	701	561	467	401	351	818	613	491	409	351	307
18,5	1050	788	630	525	450	394	1000	750	600	500	429	375	875	656	525	438	375	328

LD 0 - Lopatka 0 długa
LD I - Lopatka I długa
LK 0 - Lopatka 0 krótka
LK I - Lopatka I krótka



Tabela wysiewu

SIPMA RN 610 ANTEK

Tarcza: 430

Lopatkki 0



N 46 Mocznik PULREA

Grupa Azoty Zakłady Azotowe „Puławy” S.A.

Zawartość azotu w formie amidowej (N): 46%
Skład ziarnowy: 1-4mm, min. 90%
Gęstość nasypowa: 0,70 – 0,78 kg/dm³

Szerokość robocza	10 m						12 m						15 m						16 m						18 m					
Typ i ustawienie lopatek	LD 0 - 1,4						LD 0 - 2,4						LD 0 - 3						LD 0 - 3,2						LD 0 - 4					
	LK 0 - 1						LK 0 - 1,2						LK 0 - 1						LK 0 - 1,2						LK 0 - 1,4					
Obroty	540 obr/min						540 obr/min						540 obr/min						540 obr/min						540 obr/min					
Dawka wysiewu	kg/ha																													
Nastawa	Prędk. robocza [km/h]						Prędk. robocza [km/h]						Prędk. robocza [km/h]						Prędk. robocza [km/h]						Prędk. robocza [km/h]					
	6	8	10	12	14	16	6	8	10	12	14	16	6	8	10	12	14	16	6	8	10	12	14	16	6	8	10	12	14	16
4	77	58	46	39	33	29	64	48	39	32	28	24	51	39	31	26	22	19	48	36	29	24	21	18	43	32	26	21	18	16
4,5	98	73	59	49	42	37	81	61	49	41	35	31	65	49	39	33	28	24	61	46	37	31	26	23	54	41	33	27	23	20
5	121	91	73	60	52	45	101	76	60	50	43	38	81	60	48	40	35	30	76	57	45	38	32	28	67	50	40	34	29	25
5,5	148	111	89	74	64	56	124	93	74	62	53	46	99	74	59	49	42	37	93	70	56	46	40	35	82	62	49	41	35	31
6	185	139	111	93	79	70	155	116	93	77	66	58	124	93	74	62	53	46	116	87	70	58	50	43	103	77	62	52	44	39
6,5	222	166	133	111	95	83	185	138	111	92	79	69	148	111	89	74	63	55	138	104	83	69	59	52	123	92	74	62	53	46
7	264	198	159	132	113	99	220	165	132	110	94	83	176	132	106	88	76	66	165	124	99	83	71	62	147	110	88	73	63	55
7,5	320	240	192	160	137	120	266	200	160	133	114	100	213	160	128	107	91	80	200	150	120	100	86	75	178	133	107	89	76	67
8	373	280	224	186	160	140	311	233	186	155	133	117	249	186	149	124	107	93	233	175	140	117	100	87	207	155	124	104	89	78
8,5	433	325	260	217	186	162	361	271	217	180	155	135	289	217	173	144	124	108	271	203	162	135	116	102	241	180	144	120	103	90
9	487	365	292	244	209	183	406	305	244	203	174	152	325	244	195	162	139	122	305	228	183	152	131	114	271	203	162	135	116	102
9,5	554	415	332	277	237	208	461	346	277	231	198	173	369	277	221	185	158	138	346	260	208	173	148	130	308	231	185	154	132	115
10	637	478	382	319	273	239	531	398	319	266	228	199	425	319	255	212	182	159	398	299	239	199	171	149	354	266	212	177	152	133
10,5	704	528	423	352	302	264	587	440	352	294	252	220	470	352	282	235	201	176	440	330	264	220	189	165	391	294	235	196	168	147
11	785	589	471	392	336	294	654	491	392	327	280	245	523	392	314	262	224	196	491	368	294	245	210	184	436	327	262	218	187	164
11,5	864	648	518	432	370	324	720	540	432	360	309	270	576	432	346	288	247	216	540	405	324	270	231	202	480	360	288	240	206	180
12	961	721	577	481	412	361	801	601	481	401	343	300	641	481	385	320	275	240	601	451	361	300	258	225	534	401	320	267	229	200
12,5	1051	788	631	526	451	394	876	657	526	438	375	329	701	526	420	350	300	263	657	493	394	329	282	246	584	438	350	292	250	219
13	1147	860	688	573	491	430	955	717	573	478	409	358	764	573	459	382	328	287	717	537	430	358	307	269	637	478	382	318	273	239
13,5	1269	951	761	634	544	476	1057	793	634	529	453	396	846	634	507	423	362	317	793	595	476	396	340	297	705	529	423	352	302	264
14	1378	1033	827	689	590	517	1148	861	689	574	492	431	918	689	551	459	394	344	861	646	517	431	369	323	765	574	459	383	328	287
14,5	1494	1120	896	747	640	560	1245	934	747	622	534	467	996	747	598	498	427	373	934	700	560	467	400	350	830	622	498	415	356	311
15	1594	1195	956	797	683	598	1328	996	797	664	569	498	1062	797	637	531	455	398	996	747	598	498	427	374	885	664	531	443	379	332
15,5	1723	1292	1034	861	738	646	1436	1077	861	718	615	538	1149	861	689	574	492	431	1077	808	646	538	461	404	957	718	574	479	410	359
16	1865	1399	1119	933	799	699	1554	1166	933	777	666	583	1243	933	746	622	533	466	1166	874	699	583	500	437	1036	777	622	518	444	389
16,5	1992	1494	1195	996	854	747	1660	1245	996	830	712	623	1328	996	797	664	569	498	1245	934	747	623	534	467	1107	830	664	553	474	415
17	2152	1614	1291	1076	922	807	1794	1345	1076	897	769	673	1435	1076	861	717	615	538	1345	1009	807	673	576	504	1196	897	717	598	512	448
17,5	2275	1706	1365	1138	975	853	1896	1422	1138	948	813	711	1517	1138	910	758	650	569	1422	1067	853	711	609	533	1264	948	758	632	542	474
18	2326	1744	1396	1163	997	872	1938	1454	1163	969	831	727	1551	1163	930	775	665	581	1454	1090	872	727	623	545	1292	969	775	646	554	485
18,5	2385	1789	1431	1192	1022	894	1987	1491	1192	994	852	745	1590	1192	954	795	681	596	1491	1118	894	745	639	559	1325	994	795	662	568	497

- LD 0 - Lopatka 0 długa
- LD 1 - Lopatka I długa
- LK 0 - Lopatka 0 krótka
- LK 1 - Lopatka I krótka



Tabela wysiewu

SIPMA RN 610 ANTEK

Tarcza: 430

Lopatki I



N 46 Mocznik PULREA

Grupa Azoty Zakłady Azotowe „Puławy” S.A.

Zawartość azotu w formie amidowej (N): 46%
Skład ziarnowy: 1-4mm, min. 90%
Gęstość nasypowa: 0,70 – 0,78 kg/dm³

Szerokość robocza	12 m						15 m						16 m					
Typ i ustawienie lopatek	LD I - 2,4						LD I - 3						LD I - 3,2					
	LK I - 1,4						LK I - 1,4						LK I - 2,1					
Obroty	540 obr/min						540 obr/min						540 obr/min					
Dawka wysiewu	kg/ha																	
Nastawa	Prędk. robocza [km/h]						Prędk. robocza [km/h]						Prędk. robocza [km/h]					
	6	8	10	12	14	16	6	8	10	12	14	16	6	8	10	12	14	16
4	64	48	39	32	28	24	51	39	31	26	22	19	48	36	29	24	21	18
4,5	81	61	49	41	35	31	65	49	39	33	28	24	61	46	37	31	26	23
5	101	76	60	50	43	38	81	60	48	40	35	30	76	57	45	38	32	28
5,5	124	93	74	62	53	46	99	74	59	49	42	37	93	70	56	46	40	35
6	155	116	93	77	66	58	124	93	74	62	53	46	116	87	70	58	50	43
6,5	185	138	111	92	79	69	148	111	89	74	63	55	138	104	83	69	59	52
7	220	165	132	110	94	83	176	132	106	88	76	66	165	124	99	83	71	62
7,5	266	200	160	133	114	100	213	160	128	107	91	80	200	150	120	100	86	75
8	311	233	186	155	133	117	249	186	149	124	107	93	233	175	140	117	100	87
8,5	361	271	217	180	155	135	289	217	173	144	124	108	271	203	162	135	116	102
9	406	305	244	203	174	152	325	244	195	162	139	122	305	228	183	152	131	114
9,5	461	346	277	231	198	173	369	277	221	185	158	138	346	260	208	173	148	130
10	531	398	319	266	228	199	425	319	255	212	182	159	398	299	239	199	171	149
10,5	587	440	352	294	252	220	470	352	282	235	201	176	440	330	264	220	189	165
11	654	491	392	327	280	245	523	392	314	262	224	196	491	368	294	245	210	184
11,5	720	540	432	360	309	270	576	432	346	288	247	216	540	405	324	270	231	202
12	801	601	481	401	343	300	641	481	385	320	275	240	601	451	361	300	258	225
12,5	876	657	526	438	375	329	701	526	420	350	300	263	657	493	394	329	282	246
13	955	717	573	478	409	358	764	573	459	382	328	287	717	537	430	358	307	269
13,5	1057	793	634	529	453	396	846	634	507	423	362	317	793	595	476	396	340	297
14	1148	861	689	574	492	431	918	689	551	459	394	344	861	646	517	431	369	323
14,5	1245	934	747	622	534	467	996	747	598	498	427	373	934	700	560	467	400	350
15	1328	996	797	664	569	498	1062	797	637	531	455	398	996	747	598	498	427	374
15,5	1436	1077	861	718	615	538	1149	861	689	574	492	431	1077	808	646	538	461	404
16	1554	1166	933	777	666	583	1243	933	746	622	533	466	1166	874	699	583	500	437
16,5	1660	1245	996	830	712	623	1328	996	797	664	569	498	1245	934	747	623	534	467
17	1794	1345	1076	897	769	673	1435	1076	861	717	615	538	1345	1009	807	673	576	504
17,5	1896	1422	1138	948	813	711	1517	1138	910	758	650	569	1422	1067	853	711	609	533
18	1938	1454	1163	969	831	727	1551	1163	930	775	665	581	1454	1090	872	727	623	545
18,5	1987	1491	1192	994	852	745	1590	1192	954	795	681	596	1491	1118	894	745	639	559

LD I - Łopatka I długa
LD II - Łopatka II długa
LK I - Łopatka I krótka
LK II - Łopatka II krótka



Tabela wysiewu

SIPMA RN 610 ANTEK

Tarcza: 430

Łopatki I



N 46 Mocznik PULREA

Grupa Azoty Zakłady Azotowe „Puławy” S.A.

Zawartość azotu w formie amidowej (N): 46%
Skład ziarnowy: 1-4mm, min. 90%
Gęstość nasypowa: 0,70 – 0,78 kg/dm³

Szerokość robocza	18 m						20 m						21 m					
Typ i ustawienie łopatek	LD I - 3,4						LD I - 4						LD I - 4					
	LK I - 2,2						LK I - 2,2						LK I - 2,2					
Obroty	540 obr/min						540 obr/min						600 obr/min					
Dawka wysiewu	kg/ha																	
Nastawa	Prędk. robocza [km/h]						Prędk. robocza [km/h]						Prędk. robocza [km/h]					
	6	8	10	12	14	16	6	8	10	12	14	16	6	8	10	12	14	16
4	43	32	26	21	18	16	39	29	23	19	17	14	37	28	22	18	16	14
4,5	54	41	33	27	23	20	49	37	29	24	21	18	46	35	28	23	20	17
5	67	50	40	34	29	25	60	45	36	30	26	23	58	43	35	29	25	22
5,5	82	62	49	41	35	31	74	56	45	37	32	28	71	53	42	35	30	27
6	103	77	62	52	44	39	93	70	56	46	40	35	88	66	53	44	38	33
6,5	123	92	74	62	53	46	111	83	66	55	47	42	105	79	63	53	45	40
7	147	110	88	73	63	55	132	99	79	66	57	50	126	94	76	63	54	47
7,5	178	133	107	89	76	67	160	120	96	80	68	60	152	114	91	76	65	57
8	207	155	124	104	89	78	186	140	112	93	80	70	178	133	107	89	76	67
8,5	241	180	144	120	103	90	217	162	130	108	93	81	206	155	124	103	88	77
9	271	203	162	135	116	102	244	183	146	122	104	91	232	174	139	116	99	87
9,5	308	231	185	154	132	115	277	208	166	138	119	104	264	198	158	132	113	99
10	354	266	212	177	152	133	319	239	191	159	137	120	304	228	182	152	130	114
10,5	391	294	235	196	168	147	352	264	211	176	151	132	335	252	201	168	144	126
11	436	327	262	218	187	164	392	294	235	196	168	147	374	280	224	187	160	140
11,5	480	360	288	240	206	180	432	324	259	216	185	162	411	309	247	206	176	154
12	534	401	320	267	229	200	481	361	288	240	206	180	458	343	275	229	196	172
12,5	584	438	350	292	250	219	526	394	315	263	225	197	501	375	300	250	215	188
13	637	478	382	318	273	239	573	430	344	287	246	215	546	409	328	273	234	205
13,5	705	529	423	352	302	264	634	476	381	317	272	238	604	453	362	302	259	227
14	765	574	459	383	328	287	689	517	413	344	295	258	656	492	394	328	281	246
14,5	830	622	498	415	356	311	747	560	448	373	320	280	711	534	427	356	305	267
15	885	664	531	443	379	332	797	598	478	398	342	299	759	569	455	379	325	285
15,5	957	718	574	479	410	359	861	646	517	431	369	323	820	615	492	410	352	308
16	1036	777	622	518	444	389	933	699	560	466	400	350	888	666	533	444	381	333
16,5	1107	830	664	553	474	415	996	747	598	498	427	374	949	712	569	474	407	356
17	1196	897	717	598	512	448	1076	807	646	538	461	404	1025	769	615	512	439	384
17,5	1264	948	758	632	542	474	1138	853	683	569	488	427	1083	813	650	542	464	406
18	1292	969	775	646	554	485	1163	872	698	581	498	436	1108	831	665	554	475	415
18,5	1325	994	795	662	568	497	1192	894	715	596	511	447	1136	852	681	568	487	426

LD I - Łopatka I długa
LD II - Łopatka II długa
LK I - Łopatka I krótka
LK II - Łopatka II krótka

